

# RECTIFIERS

New-Era No.	Ref.No.	Application
<b>D-001</b> <b>AC12V 50A</b> 	9-82231-619-0 5-81218-001-0 5-81218-021-0 5-81218-022-0 23230-U0100 23230-U0101 23232-B8000 23232-H6200 23232-N3300 31441-00808	<b>ISUZU</b> ELF 150,250  <b>NISSAN</b> CEDRIC 2600      RHF230V,KHF230Q      74~ CEDRIC      330,K330,V330,C-331      75~ GLORIA      330,K330,V330,C-331      75~ LAUREL      C30,SGX,GL-6      71~ LAUREL 2000      C130      73~ SKYLINE 2000 GTX      GC110,GCK110TK      72~ SKYLINE      A-C110      76~ SKYLINE      C110      76~77 SKYLINE      C-120,111(L20),      78~ WE-PC211(Z18S)  NEW SILVIA      A-S10      75~ VIOLET      710,P710,K710,KP710(E),      73~ JP710D,JP710HT,P710WK, P710WPE  CHERRY      F10      75 PATROL      60      76 CARAVAN      E20      73~ FAIRLADY 240Z      HS60      71~ FAIRLADY      GS30,GS30S      74~ BLUEBIRD      610,E-P811,E-PJ811      71~74 SUNNY      B210,PB210,B-B211,HB211,      74~ B-B211,E-B310 TRUCK      60,780,790      72 STANZA      E-RA11(Z18E)      78~ PULSAR      E-YN10(A12AS)      78~  <b>SUBARU(FUJI)</b> 1400      A22H      73~ A22C, A22Y, A22J      75~
	L125-6320 HI L125-8320 HI L140-6320 HI L140-9320 HI	
<b>D-006</b> <b>AC12V 50A</b> 	8173-24-510A	<b>MAZDA</b> 323 1500,1300      [GENERAL]      80~82 323 1500 SPORTS      [EC]      80~82 323 1100      [EC]      80~82  <b>FORD</b> LASER 1500,1300      BD1031(E5,E3)      80~83
	W/CONDENSER A860T07270 MI	
<b>D-007</b> <b>AC12V 40A</b> 	S501-24-510	<b>MAZDA</b> TITAN 3000 DIESEL      TA3H4      80 2500 DIESEL      XA,EXR15      81 E3000 DIESEL TRUCK
	W/LEAD WIRE(L TERMINAL) A860T06570 MI	

# RECTIFIERS

New-Era No.	Ref.No.	Application
<b>D-013</b> <b>AC12V 55A</b>  80mm	E563-24-510	<b>MAZDA</b> FAMILIA [USA][EC] 82~  <b>FORD</b> LASER 1500 82~
	W/CONDENSER	A860T10770 MI
<b>D-016</b> <b>AC24V 20A</b> <b>AC12V 35A</b>  71mm	23124-U0114	<b>MITSUBISHI</b> FORKLIFT(4DQ) FD30,25,20(S4E) 83~  <b>NISSAN</b> JUJOR (A12S)[GENERAL] 82~ PICK UP (A12S)[GENERAL] 82~ [EC][SWITZERLAND] PULSAR 1200 E-YN10,J-VN10 (A12S) 82~ SUNNY 1200 VAN J-VB310(A12S) 82~ TRUCK 1800 (L18) 83~ PICK UP 1800 (L18)[AUSTRALIA] 83~ [SAUDI ARABIA]
		A860T09470 MI
<b>D-017</b> <b>AC12V 50A</b>  80mm	23124-W5811	<b>NISSAN</b> SKYLINE 1800 VAN R30(Z18S) 81~83 BLUEBIRD 1600 VAN V910(Z16S) 81~83
		A860T08470 MI
<b>D-019</b> <b>AC24V 30A</b>  85mm	ME700636	<b>MITSUBISHI</b> LARGE TRUCK(THE GREAT) 84~ FU415,FV415 FS415(8DC) LARGE TRUCK FK(6D14,6D15) 83~ MIDDLE TRUCK(FIGHTER) P-FK515 83~ (6D14,6D15)
	W/CONDENSER	A860T15170 MI
<b>D-021</b> <b>AC12V 50A</b>  80mm	MD607616	<b>MITSUBISHI</b> PAJERO 2300 DIESEL LO43G(4D55) 81~83 PAJERO 2300 DIESEL TURBO N-LO43G(4D55) 82~86 (4D5) CANTER (4D5) 82~ GALANT(Λ,Σ)2300 DIESEL (4D55) 82~87 DELICA 2300 DIESEL LO38,LO68(4D55) 82~86 DELICA STARWAGON 2300 4WD N-LO38PW(4D55) 82~86 DELICA 2300 4WD,4WD TURBO N-LO38TV,N-LO38GW(4D55) LO38,LO68(4D55) 82~86 DELICA 2300 DIESEL K-A167A(4D55) 81~ GALANT Λ,2300 DIESEL K-A167A(4D55) 81~ GALANT Σ,2300 DIESEL
		A860T08270 MI

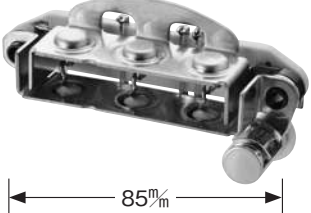
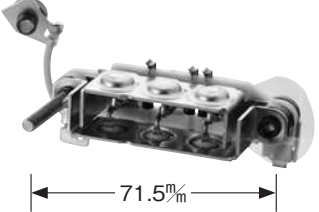
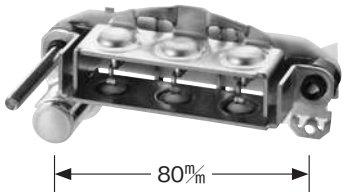
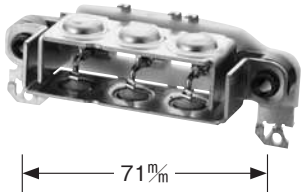
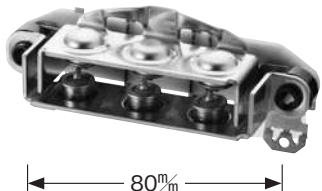
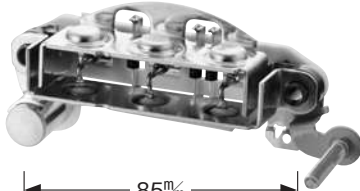
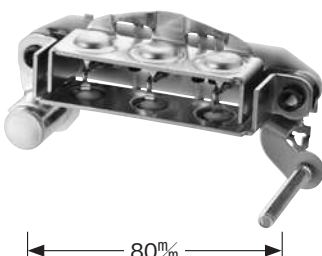

# RECTIFIERS

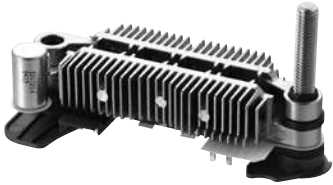
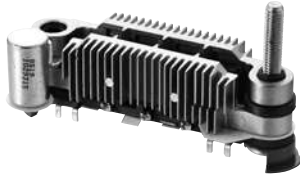
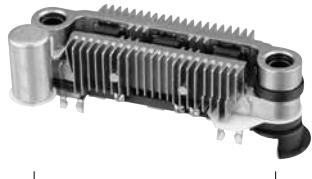
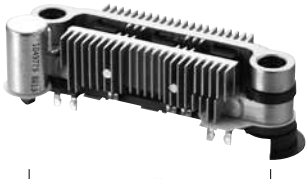
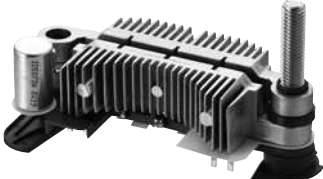
New-Era No.	Ref.No.	Application
<b>D-028</b> <b>AC12V 90A</b>  100mm	<b>JE48-18-W60B</b>  <b>A860T36770 MI</b>	<b>MAZDA</b> EFINI MS-9 SENTIA HD5S(J5) HDES(JE) HDES,HDEP(JE) HD5P,HD5S(J5) 91~97 91~97 91~97 91~97
<b>D-029</b> <b>AC12V 55A</b>  75mm	<b>31621-60A20</b>  <b>A860T30370 MI</b>	<b>SUZUKI</b> CULTUS ESTEEM AH14S,AJ14S(G16A) AH64S,AJ64S(G15A) 89~93 89~93
<b>D-030</b> <b>AC12V 65A</b>  75mm	<b>B366-18-W60</b>  <b>A860T32570 MI</b>	<b>MAZDA</b> FAMILIA EUNOS 100 RASER BG3P, BG3S(B3) BG5P, BG5S(B5) BG6P, BG6S, BG6Z(B6) BG8P, BG8R, BG8Z(BP) BG5PE(B5) BG8PE(BP) BG5PF(B5) BG6RF(B6) BG8RF(BP) 89~91 89~91 89~91 89~91 89~91 89~91 89~91 89~91
<b>D-031</b> <b>AC12V 75A</b>  75mm	<b>MD611256</b> <b>MD611307</b>  <b>A860T16970 MI</b> <b>A860T17770 MI</b> <b>A860T22570 MI</b> <b>A860T22670 MI</b>	<b>MITSUBISHI</b> MIRAGE, LANCER GALANT, ETERNA CHARIOT DELICA PAJERO STARION FORKLIFT C37W(G37B) E32A(4G37) E11A(G32B) E12A(G37B) E13A(G62B) E15A(G63B) E31A(4G32) E32A(4G37) E37A(4G37) D05W(G37B) D08W(G63B) L036P, L036PY(G33B) L063P, L063PY(G32B) P02V, P12V(G32B) P01V(G33B) P23V(G63B) L041GV(G63B) A187A(G54B) (4G33) 89~92 85~94 85~94 85~96 85~92 85~92 85~00 85~00 85~00 85~94 85~92 86~94 86~94 86~94 86~94 86~96 86~98 87~97 86~96
<b>D-032</b> <b>AC12V 80A</b>  85mm	<b>MD618950</b> <b>MD618734</b> <b>23124-K8470</b>  <b>A860X42770 MI</b> <b>A860X49270 MI</b>	<b>MITSUBISHI</b> RVR CHARIOT STRADE CHALLENGER RVR DELICA PAJERO N28W, N28WG(4D68) N38W, N48W(4D68) K74T(4D56) K94W, K94WG(4D56) N28W/N28WG P05V/P15V/P25V/P45V P05T/P15T/P25T PA5V/PB5V/PD5V V24C/V24W 93~97 92~97 98~99 93~99 92~93 94~00 94~00 94~95 93~99

# RECTIFIERS

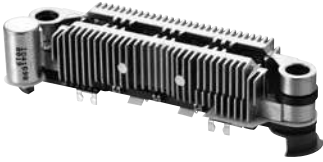
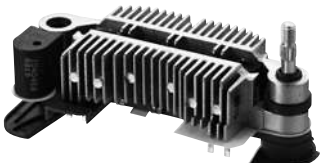
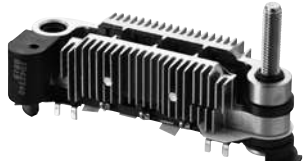
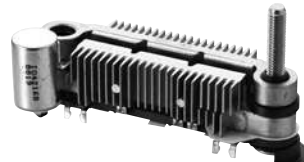
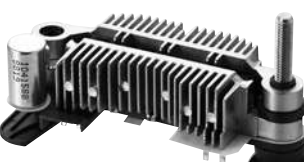
New-Era No.	Ref.No.	Application
<b>D-033</b> <b>AC12V 90A</b>  100 <sup>mm</sup>	<b>MD611564</b> <b>MD611768</b>  <b>A860T23070 MI</b> <b>A860T35270 MI</b> <b>A860T28070 MI</b>	<b>MITSUBISHI</b> MIRAGE C53A, C63A(4G61) 87~97 C73A, C83A(4G61) 87~97 C38A(4G61) 89~93 LANCER C63A, C73A(4G61) 87~97 DELICA P03W, P23W(G63B) 86~ P04W, P24W(4G64) 86~ P03V, P13V(G63B) 86~ PAJERO V23C, V23W, V43W(6G72) 90~97 L141G, L141GW(6G72) 88~97 L146GW(6G72) 88~97 ETERNA E33A, E39A(4G63) 87~94 E35A(4G67) 87~94 ECLIPSE D22A, D27A(4G63) 87~97 RVR N13W, N23W(4G63) 87~96 GALANT E33A, E39A(4G63) 87~94 E35A(4G67) 87~94 CHARIOT N33W, N34W(4G63) 87~97 FORKLIFT (4G63) 91~96
<b>D-034</b> <b>AC12V 70A</b>  85 <sup>mm</sup>	<b>B66S-18-W60</b> <b>B66S-18-W60B</b>  <b>A860T39170 MI</b> <b>A860T37670 MI</b>	<b>MAZDA</b> FAMILIA BG8Z(BP) 91~97 BG8P, BG8S(BP) 91~96 BG3P, BG3S(B3) 91~96 BG5P, BG5S(B5) 91~96 BG6R, BG6Z, (B6) 91~96 EUNOS 100 BG5PE(B5) 91~96 BG8PE(BP) 91~96 AUTO ZAM AZ-3 EC5SA(B5) 91~97 PRRESO EC5S(B5) 91~97 RASER BG3PF(B3) 91~96 BG5PF(B5) 91~96
<b>D-035</b> <b>AC12V 70A</b>  75 <sup>mm</sup>	<b>23124-77A10</b> <b>23124-77A40</b>  <b>A860T27270 MI</b> <b>A860X27299 MI</b> <b>A860X36499 MI</b>	<b>NISSAN</b> SUNNY CALIFORNIA PULSAR Y10(GA15DS) 90~92 N14(GA13DS, GA15DS) 90~92 N14(GA16DE) 90~92 AD Y10(GA13DS, GA15DS) 90~92
<b>D-036</b> <b>AC12V 70A</b>  75 <sup>mm</sup>	<b>F8B1-18-W60</b>  <b>A860T27170 MI</b>	<b>MAZDA/FORD</b> CAPELLA GD8A, GD8B, GD8P(F8) 87~94 GD8R, GD8S(F8) 87~94 GDEA, GDEB(FE) 87~94 GDEP, GDER(FE) 87~94 GDES(FE) 87~94 CAPELLA CARGO GV8W(F8) 87~94 GVER(FE) 87~94 TELSTAR GD8AF, GD8PF(F8) 87~94 GD8RF(F8) 87~94 GDEAF, GDEPF(FE) 87~94 GDERF(FE) 87~94 PROBE BT21C, BT21L(F2) 87~94 PERSONA MA8P(F8) 87~94 MAEP(FE) 87~94
<b>D-037</b> <b>AC12V 80A</b>  85 <sup>mm</sup>	<b>MD618568</b>  <b>A860T38770 MI</b>	<b>MITSUBISHI</b> RVR MIRAGE, ASTY N11W, N21W, N21WG(4G93) 91~98 CA3A, CB3A, CC3A(4G91) 91~98 CD3A CA4A, CC4A(4G92) 91~98 LANCER CB3A, CD3A(4G91) 91~98 CD5A, CB5AR(4G93) 91~98 CB4A(4G92) 92~96 LIBERO CB5W, CD5W(4G93) 91~98 ETERNA E52A, E72A(4G93) 92~98 GALANT E52A, E72A(4G93) 92~98 EMERAUDE E52A(4G93) 92~95

# RECTIFIERS

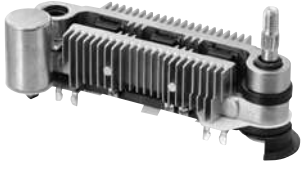
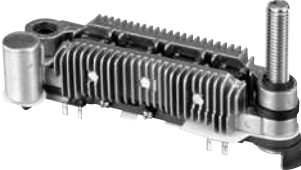
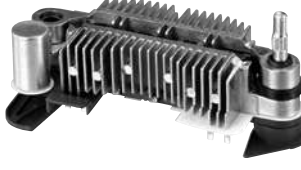
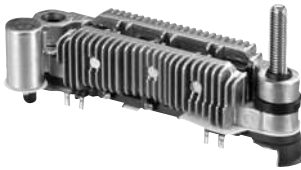
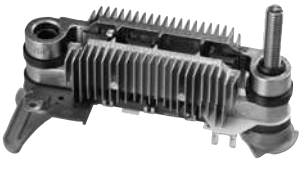
New-Era No.	Ref.No.	Application
<b>D-038</b> <b>AC12V 60A</b>  75mm	<b>B675-18-W60</b>  <b>A860T27070 MI</b>	<b>MAZDA/FORD</b> ETUDE      BFMP, BFSP(B5,B6)      86~95 CAPELLA (626)      GD6P(B6)      86~95 CAPELLA CARGO      GV6V(B6)      86~95 FAMILIA      BFMP, BFMR,(B3, B5, B6 ,E3, E5)      86~95 BFSP BFSR, BFTP,      86~95 BF3V BF5V, BF6M,      86~95 BW3W BW5W, BWMR      86~95 <b>RASER</b> BF3VF, BF5VF,(E3,E5,B6)      86~95 BE6ME
<b>D-039</b> <b>AC12V 80A</b>  85mm	<b>JF07-18-W60</b>  <b>A860T32170 MI</b>	<b>MAZDA</b> LUCE      HCFS(JF)      88~98 HCSS(JE)      88~96
<b>D-040</b> <b>AC12V 80A</b>  85mm	<b>FS05-18-W60</b>  <b>A860T38970 MI</b>	<b>MAZDA</b> ε fini MS-6      GESR(FS)      91~97 (MAZDA 626)      (FP)      91~97 Capella      CG2PP CG2SP(FS)      91~97 (MAZDA 626)      CG2SR(FS)      91~97 Cronos      GESR(FS)      91~97 Eunos 500      CAPP(FP)      91~97  <b>AUTOZAM</b> Clef      GESRA(FS)      91~97  <b>FORD</b> Telstar      GESRF(FS)      91~97 Telstar II      CG2PPF(FP)      91~97 CG2SPF(FS)      91~97 CG2SRF(FS)      91~97
<b>D-041</b> <b>AC12V 70A</b>  85mm	<b>JE15-18-W60</b> <b>F285-18-W60</b>  <b>A860T31370 MI</b> <b>A860T34070 MI</b>	<b>MAZDA</b> MPV      LVEW, LV5W(JE, G5)      88~98 LUCE      HCEP, HC2J(FE, F2)      88~98 EUNOS300      MA8PE, MAEPE(F8, FE)      89~94
<b>D-042</b> <b>AC12V 80A</b>  75mm	<b>31127-RSH-004</b> <b>31127-PWA-004</b>  <b>A005TB0291 MI</b> <b>A005TB1391 MI</b>	<b>HONDA</b> JAZZ      07~08 FIT      07~08 CITY      05~08



# RECTIFIERS

RECTIFIERS

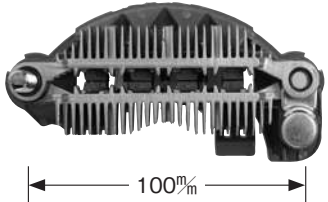
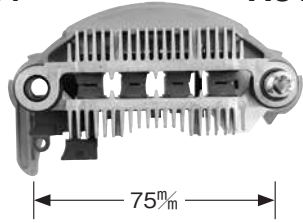
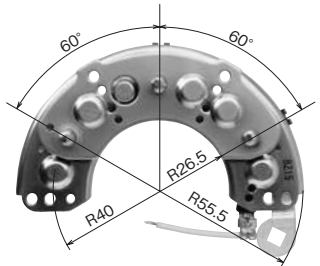
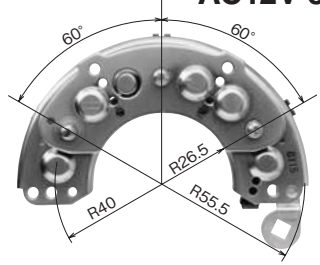
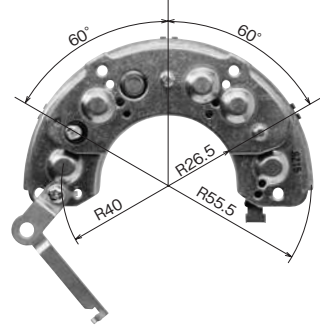
New-Era No.	Ref.No.	Application
<b>D-043</b> <b>AC12V 120A</b>  8 DIODES	<b>ME701716</b>  <b>A860X61870</b>	<b>MITSUBISHI</b> CHALLENGER DELICA SPACE GEAR PAJERO K97WG(4M40) 96~00 PD8W,PE8W,PF8W(4M40) 96~00 V26C,V46V,V26WG(4M40) 96~00 V46W,V46WG(4M40)
<b>D-044</b> <b>AC12V</b>  4 DIODES	<b>1800A103</b>  <b>A860X92870 MI</b>	<b>MITSUBISHI</b> MIRAGE AI A05A(3A90) 12~ HA1W(3B20) 05~
<b>D-051</b> <b>AC12V 50A</b> 	<b>8-94237729-0</b> <b>23232-W1700</b>  <b>L150-13204 HI</b>	<b>ISUZU</b> FARGO FARGO TURBO FARGO DIESEL TURBO GEMINI DIESEL GEMINI DIESEL TURBO FASTER,RODEO 4WD RODEO BIG HORN 4FC1 82~ 4FD1 84~ 4FC1T 84~ 4FC1 85~ 4FC1T 83~ 4FB1 82~ 4FB1T 82~ C190 82~ C223 85~  <b>NISSAN</b> DATSUN TRUCK CEDRIC,GLORIA LAUREL VANETTE SD22 81~ LD28 81~ LD28 81~ LD20 81~
<b>D-052</b> <b>AC24V 25A</b> <b>AC12V 50A</b> 	<b>8-94223968-0</b>  <b>L150-13205 HI</b>	<b>ISUZU</b> GEMINI DIESEL 117 COUPE DIESEL FLORIAN DIESEL RODEO BIG HORN 4WD RODEO BIG HORN ELF250 4FB1 82~ C223 82~ C190 82~ C223 81~ C223 84~ 4BA1,4BC1 82~
<b>D-053</b> <b>AC24V 40A</b> <b>AC12V 50A</b> 	<b>5-81262006-0</b> <b>23230-W7101</b>  <b>L150-13206 HI</b>	<b>ISUZU</b> 6BD1  <b>NISSAN</b> SUNNY PULSAR BLUEBIRD 1600,1800,2000 SUNNY LEPRIX TURBO LAUREL SPIRIT TURBO SAFARI FIRE ENGINE PRAIRIE ATLAS 200,300 ATLAS CIVILIAN CONDOR 20,30 NEW CONDOR CONDOR(CRANE,MIXER,TRAILER) E13S,E15E,E15S 81~ E15S 81~ Z16S,Z18S,Z20E 81~ E15E,E15T 82~ E15E,E15T 82~ PF40 81~ CA18S 82~ ED33 81~ ED33 84~ ED33 84~ FD6 81~ FD6 83~ FD6,FD6T 84~  <b>ISEKI</b> TRACTOR 6BD1 85~

# RECTIFIERS

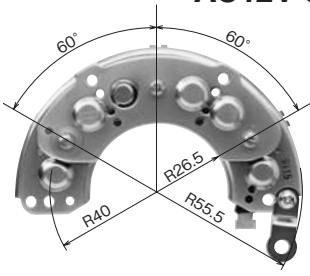
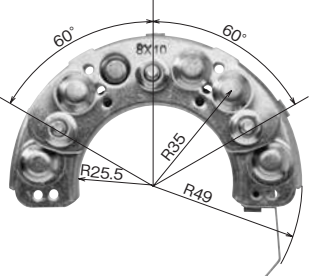
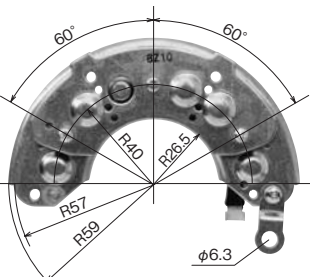
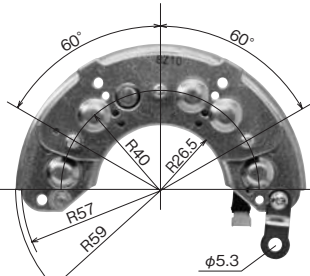
New-Era No.	Ref.No.	Application
<b>D-056</b> <b>AC24V 35A</b> <b>AC12V 60A</b> 	23232-10G01 23232-09W01 23232-18G00 23232-V6601 23232-18A00	<b>NISSAN</b> ATLAS 100 SD23 82~ ATLAS 150 SD25 82~ DATSUN TRUCK SD23 82~ DATSUN VANETTE LD20 84~ CARAVAN SD23 83~ SAFARI SD33 83~ SD33T 85~ SAFARI VAN SD33 83~ SAFARI TURBO SD33,SD33T SUNNY CD17 85~ PULSAR CD17 85~
	L140-13202 HI L140-53202 HI L150-83201 HI L150-83202 HI L160-4320 HI	
<b>D-057</b> <b>AC12V 40A</b> 	5-81218027-0 5-81218029-0 1456-24-510	<b>ISUZU</b> ELF150 KAD(C190) ELF250 TLD(C240) KB20(C190)AFRICA  <b>MAZDA</b> BONGO DIESEL BA25(S2)
	L130M-1330 HI L140-23201 HI	
<b>D-060</b> <b>AC12V 70A</b> 	23232-02N09	<b>NISSAN</b> DATSUN TRUCK N-D21(TD23) 88. 5~ SAFARI S-VRY60(TD42) 88. 5~ ATLAS H40(TD27) 88. 5~ N-EF22(SD23) 88. 5~ N-EF22(TD23) CARAVAN E-KE23(TD23) 88. 5~ E-KE23(TD27) 88. 5~ N-VYE23(SD23) 88. 5~ N-VYE23(TD23) N-DRGE24(TD27) 87. 9~ N-KSE24(LD20T) 89. 5~
	L160-13203 HI L170G-63201 HI	
<b>D-061</b> <b>AC12V 70A</b> 	23232-10G00 23232-G5703	<b>NISSAN</b> VANETTE S-VUJNC22(LD20 II) 85. 8~ VANETTE VAN S-VUJNC22(LD20 II) 93.12~ VANETTE TRUCK S-UGJC22(LD20 II) 93.12~
	L160-43202 HI L170G-33202 HI	

RECTIFIERS

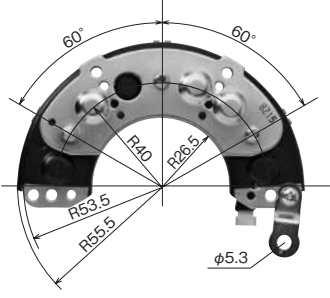
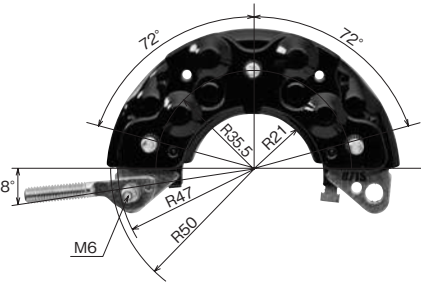
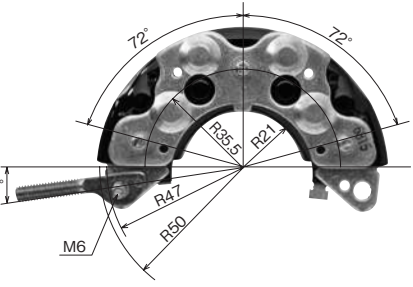
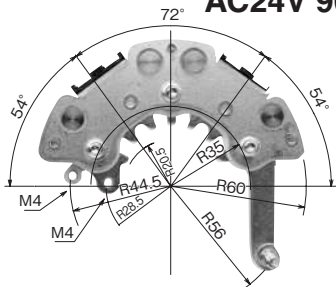
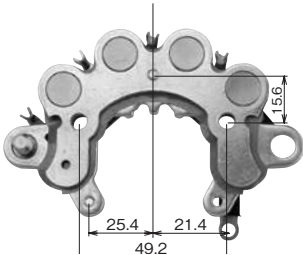

# RECTIFIERS

New-Era No.	Ref.No.	Application
<b>D-062</b> <b>AC24V 25A</b> 	8-94475472-0	<b>ISUZU</b> ELF250 NKR (4BE1,4BG1)      90.5~ L225-6320 HI
<b>D-065</b> <b>AC12V 80A</b> 	23230-51E00	<b>NISSAN</b> BLUEBIRD      E-RU12,RNU12(CA18DE,DET)      87~ L180-43201 HI
<b>D-066</b> <b>AC12V 70A</b> 	23230-D4400	<b>NISSAN</b> BLUEBIRD      E-RU11(CA16S)      86~ PULSAR      E-U11(CA18E, ET, DET)      86~ PULSAR 1.8L Eng      87 STANZA      88~89 L170-7302 HI      87~89 L170G-73202 HI
<b>D-069</b> <b>AC12V 70A</b> <b>AC24V 90A</b> 	23230-86N00	<b>NISSAN</b> CEDRIC, GLORIA      Q-UY32(RD28)      91~99 BLUEBIRD      Q-SU13(CD20)      93~96 CREW      K30(RD28)      91~93 VANETTE SERENA      Q-KVC23(CD20T)      94 AVENIR WAGON      Y-SW10(CD20T)      94~96 L190G-33201 HI L190G-83204 HI
<b>D-600</b> <b>AC12V 65A</b> 		<b>NISSAN</b> CUBE      Z10(CG13DE)      97~99 Rectifier for Rectifier Assembly <b>DIVR-860600</b>

# RECTIFIERS

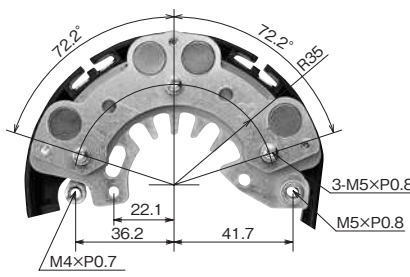
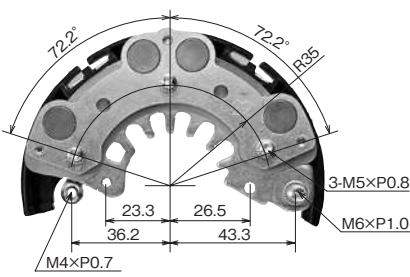
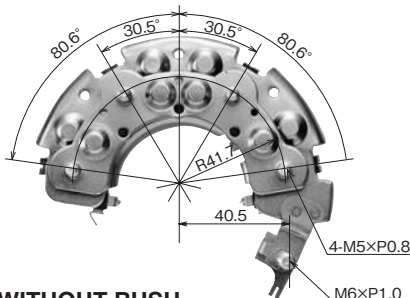
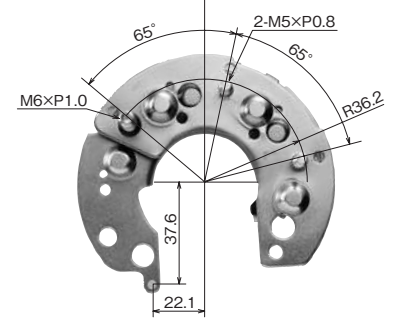
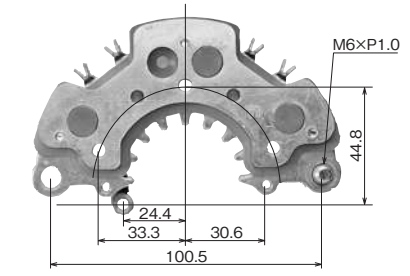
New-Era No.	Ref.No.	Application
<b>D-601</b> <b>AC12V 70A</b> 	<b>23830-AA040</b>  <b>L170-33202 HI</b>	<b>SUBARU (FUJI)</b> LEGACY      BC4, BC5(EJ20)      89~
<b>D-602</b> <b>AC12V 70A</b> 	<b>23230-0E705</b>  <b>L170G-2320 HI</b>	<b>NISSAN</b> PULSER      EN14, FNN14(GA16, GA15)      90~94 SUNNY      EB13, FB13(GA16, GA15)      90~94
<b>D-603</b> <b>AC12V 90A</b> 	<b>23230-30P00</b> <b>23230-F6500</b>  <b>L180-93201 HI</b> <b>L190-4320 HI</b>	<b>NISSAN</b> FAIRLADY Z      Z32(VG30DE)      88~93 LEOPARD      UF31(VG20DET)      86~88
<b>D-604</b> <b>AC12V 60A</b> 	<b>23230-04P01</b>  <b>L160-33201 HI</b>	<b>NISSAN</b> CEDRIC      Y30(VG20E)      83~97
<b>D-605</b> <b>AC12V 100A</b> 	<b>23230-0L700</b>  <b>L1100G-23201 HI</b>	<b>NISSAN</b> CEFIRO      A33(VQ20DE, 25E-Di, 30DE)      97~

RECTIFIERS

# RECTIFIERS

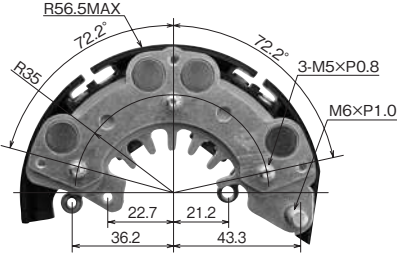
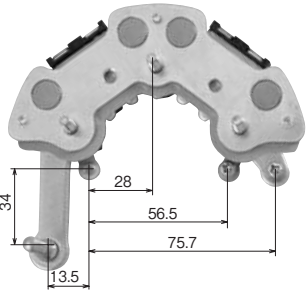
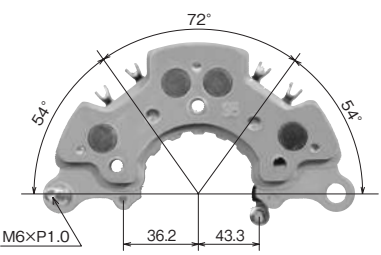
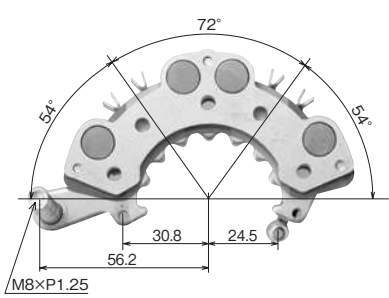
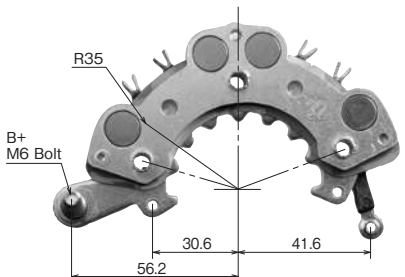
New-Era No.	Ref.No.	Application	
<p><b>D-606</b>      <b>AC12V 70A</b></p> 	<p>23230-50Y09</p> <p>L170G-1320 HI</p>	<p>NISSAN NX COUPE NX SENTRA</p>	<p>EB13(GA16DS)      90~</p>
<p><b>D-607</b>      <b>AC24V 60A</b></p> 	<p>8-97083286-0</p> <p>L250G-1320 HI</p>	<p>ISUZU ELF</p> <p>MAZDA TITAN</p>	<p>NKR,NPR(4HF1,4HG1,4HJ1) NPR,NQR(4HE1)      97~04 98~99</p> <p>WG64,WG3(4HG1,4HF1)      95~97</p> <p>Rectifier for Rectifier Assembly <b>DIVR-864607</b></p>
<p><b>D-608</b>      <b>AC24V 80A</b></p> 	<p>8-97249333-0</p> <p>L280G-1308 HI</p>	<p>ISUZU ELF</p>	<p>NKR,NPR(4HJ1,4HK1,4HL1) NKR,NPR(4HG1,4HF1,4HJ1)      02~ 00~03</p> <p>Rectifier for Rectifier Assembly</p>
<p><b>D-609</b>      <b>AC12V 80A</b></p> 	<p>8-98014279-0</p>	<p>ISUZU D-MAX</p>	<p>TFR77(4JH1)      02~06</p> <p>Rectifier for Rectifier Assembly</p>
<p><b>D-610</b>      <b>AC24V 50A</b></p> 	<p>8-97148169-1</p> <p>L250G-5308 HI</p>	<p>ISUZU ELF</p>	<p>NKR,NPR(4HF1,4HG1,4HJ1)      97~</p> <p>Rectifier for Rectifier Assembly <b>DIVR-865610</b></p>



# RECTIFIERS

New-Era No.	Ref.No.	Application
<b>D-090</b>	<b>AC24V 30A</b>	<b>DAIHATSU</b> ROCKY F300S(HD-E) 92~93 APLAUSE A101S/111S(HD) 89~96 CHARADE G200S/201S/203S/213S(HC-E/EG) 93~94  <b>HONDA</b> ACCORD AC,AD,CA6(EY,ES,A20A3) 83~85,88~ CIVIC EF9,EG3/4/5/7/8,EH1,EJ1/3 89~ (B16A,D13B/15B,ZC,D16A) CR-X EF8,EG1,EJ4(B16A,D15B/16A) 89~96 DOMANI MA4/6/7(ZC,D15B) 92~96 INTEGRA DA5/6/7/8,DB6/8/9,DC1/2 89~ (ZC,B16A/18C) LEGEND KA1/2/3/4/5/6(C20A/27A) 85~90 PRELUDE BA1/4/5/7(B20A/21A) 85~91 VIGOR AD,CA1/2/3/5 83~89 (ES,A18A/20A,B18A/20A)  <b>ISUZU</b> BIG HORN UBS25DW/25GW/69DW/69GW(6VD1,4JG2) 92~ GEMINI MJ1/2(ZC) 93~  <b>SUZUKI</b> ESCUDE TA51W/51W(J20A) 97~ CULTUS GC41W,GA11S/21S,GC21S 95~ (J18A,G13B/15A/16A) GD31S/31W  <b>TOYOTA</b> CAMRY, VISTA CV40(3C-T) 94~ SV10/11/12/20/21/22/25/30/32/33/35/40/43 82~94 (1S-ILU-/LU/-I,2S-ELU,3S-GELU/-FE/GE, 4S-FE) VZV20/30/31/32/33(1VZ-FE,4ZV-FE) 90~94 CARDINA ST190G/195G(3S-FE/-GE,4S-FE) 92~97 CARINA AA63/151/160/170/170G/171/175/190/19 83~ 1/192/210(4A-ELU/-FE/-FHE/-GE/-GELU/- GEU,5A-FE,7A-FE) ET176V(3E) 89~92 ST150/160/162/163/170/170G/215 84~ (1S-ILU,3S-FE/-GELU,4S-FI) CELICA AA63(4A-GEU) 83~85 AT160(4A-GELU) 85~87 GA61(1G-GEU) 82~86 MA61/63(M-TEU,5M-GEU) 83~85 ST160/162/163/165 85~89 (1S-ILU,3S-FE/GELU/-GTE,) COMFORT SXS11Y,YXS10/11/11Y(3Y-PE,4S-FE) 95~ COROLLA, AE100/100G/101/101G/104/104G/109V/110/1 83~ SPRINTER 11/111G/114/82/86/91/91G/92/95 (4A-ELU/-FE/-GE/-GELU/-GEU,5A-FE/-FHE) CE100G/106V/108G(2C) 95~98 EE101/102V/103V/104G/106V/107V/108G/ 91~ 111/90/96V/98V(2E,3E,4E-FE,5E-FE) CORONA AT141/160/170/175/190 83~96 (4A-FE/-GELU/-GEU,5A-F) ET176V(3E) 88~92 ST150/160/162/163/170/171/190/190Y/ 83~ 195/215 (1S-ILU-/LU/,3S-FE/-GE/-GELU,4S-FE/-FI) YT140(2Y-PU) 89~ CORSA, EL41/43/45/51(4E-FE,5E-FE/-FHE) 92~97 COROLLA II NL30(1N-T) 86~90 EL30/31/41/43/45 86~92 (2E,3E,3E-TE,4E-TE,5E-FE) NL30/40/50(1N-T) 86,94~97 CROWN GS121/130/130G/130W/131/131H/141 83~ (1G-FE/-GEU/-GP/-GZU) LS130/136V(2L,2L-T) 89~94 MS120/122Z/123/125/130 83~89 (5M-EU/-GEU,6M-GEU,M-P/-PU/-TEU) YS120/130(3Y-P/-PE/-PU) 83~95 DELTA BU100N/102J/102N/107N/112M/112N/112T/ 95~ 112U/142N/147N/162J/162M/162N/162U/ 172N(15B-F,3B) V115/116/118/118D/119/98/98D/99 88~95 (14B,14B-T,B)
	<b>AC12V 80A</b>	

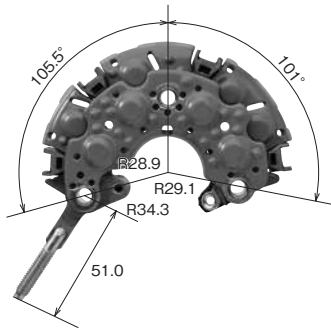

021580-2160 ND  
021580-2230 ND

CONTINUED

# RECTIFIERS

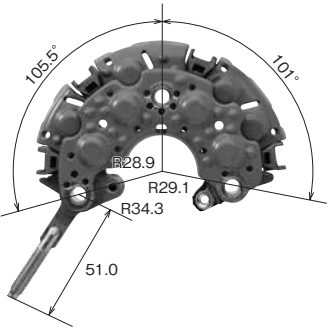
New-Era No.	Ref.No.	Application
<b>D-090</b> <b>AC24V 30A</b> <b>AC12V 80A</b> 	<b>27357-87101-000</b> <b>31127-PD2-0140</b> <b>8-94160638-0</b> <b>31621-77E20</b> <b>27357-63020</b> <b>16540-64851</b>	<b>DELTA WIDE</b> CB21G(2C-T) 85~90 YB20G/21G(2Y,2Y-U,3B,3Y) 83~91 <b>DYNA,</b> BU100/100A/102/102A/102D/102H/105/107 88~ <b>TOYOACE</b> /112/112A/112D/120V/132/137/140/142/147 /162/162A/162D/172/182/202/212/212K/222 /60/61/66/66D/66H/67/67D/68DH/70V/70VH /72/72D/72DH/72H/73/74/78/83/84/87/87V/88 /91/94/96(11B,14B,14B-T,15B-F/-FT,3B,B) RZU100/100A/100H(3RZ-FE/-FP) 95~97 YY51(2Y) 90~93 <b>HIACE</b> LH102V/103V/109V/113K/113V/119V/123V/ 129V(2L,3L) 89~ RZH100G/102V/110G/112K/112V/122V/124B (1RZ,1RZ-E) YH51G/57G/61G(3Y-U) 87~89 <b>HILUX</b> KZN130G/130W/185G/185W(1KZ-TE) 93~97 LN108/112/130G/130W/131V,RN50(2L-TE,3L) 90~96 YZN130G(3Y-E) 89~91 YN130G/61G(3Y-E/-EU) 86~91 <b>LAND CRUISER</b> BJ70/70V/73V(3B) 88~90 HDJ81V(1HD-T) 90~92 HZJ73HV/73V/77HJ/81V(1HZ) 90~92 KZJ90W/95W(1KZ-TE) 96~ PZJ70/70V/77HZ/77V(1PZ) 90~92 YZJ90W(5VZ-FE) 96~ HDJ81V(1HD-T) 92~95 HZJ70/70V/73HV/73V/77HV/77V/81V(1HZ) 92~ PZJ70/70V/77HV/77V(1PZ) 92~94 <b>MARK II,</b> GX100/61/70G/71/90(1G-FE/-GEU/-GTEU) 84~ <b>CHASER</b> LX76V/80/80Y(2L,2L-T) 88~ MX60/61/71(M-PU/-TEU) 83~85 YX70/70A/70YA/78V/80/80Y(2Y-PU,3Y-E/-P) 84~97 GX70G/71/81(1G-FE/-GE/-GEU/-GTE) 86~93 SX80/80Y/90(4S-FE) 88~96 YX70/70YA/72/72Y/80/80Y(2Y-PU,3Y-P/-PU) 85~95 <b>MASTER ACE</b> CR21G/28G/30G/37G(2C,2C-T) 85~90 YR20G/21G/28G/30G/36G,RR28G (2Y-U,3Y-EU) 85~92 RR28G(2Y-U) 85~86 <b>MR2</b> AW10/11(3A-LU,4A-GELU) 84~89 <b>RANGER</b> BU100M/102E/102M/102T/102X/107M/112M /112T/112X/142M/147M/162M/162T/162X /172M/182M/202M/212M/222M(3B,15B-F) 88~ HV115/116/118/119/98/98D/9(14B,B) 88~ <b>RAV4</b> SXA10G/10W/11G/11W(3S-FE/-GE,4S-FE) 94~97 <b>SOARER</b> GZ10/20(1G-FE/-GEU/-GTEU) 83~91 MZ10/11/12/20 83~87 (M-TEU,5M-GEU,6M-GEU,7M) <b>SPRINTER</b> AE111G/114G/115G/95G(4A-FE/-FHE,7A-FE) 88~ <b>STARLET</b> EP85/91/95(4E-F/-FE/-FTE) 92~ NP70/76V/80/90(1N) 86~97 <b>SUPRA</b> GA70/70H(1G-FE/-GEU/-GTEU) 86~93 MA70(7M-GTEU) 86 <b>TOWNACE</b> CM30G/40G,CM40G,CR-21G/28G/30G/37G, YM30G/40G/55/YR20G/21G/25V/28G/30G/36G (2C-T,2Y,2Y-J/-U,3Y-EU/-U) 85~92 <b>TOWNACE,</b> CM30G/41V/50/51/55/65,CR21G/26V,YM30G 84~90 <b>LITEACE</b> /40G,YR20G/21G/28G (1C,2C,2Y-U,3Y-EU,3Y-U)
		<b>021580-2160 ND</b> <b>021580-2230 ND</b>

RECTIFIERS

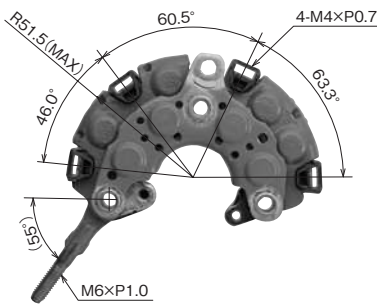

# RECTIFIERS

New-Era No.	Ref.No.	Application		
<b>D-091</b> <b>AC12V 60A</b> 	<b>31621-75F00</b> <b>8-97171368-0</b> <b>27357-11130</b> <b>27357-87712-000</b> <b>MD627094</b> <b>35999-17671</b>	<b>DAIHATSU</b> CHARADE PYZAR TERIOS ATRAI 7  <b>ISUZU</b> VEHI CROSS BIGHORN  <b>MAZDA</b> AZ-WAGON CAROL SPIANO  <b>MITSUBISHI</b> MINICAB  <b>NISSAN</b> MOCO CLIPPER  <b>SUZUKI</b> WAGON R WIDE  CULTUS  ESCUDO JIMNY KEI LAPUTA MR WAGON ALTO ALTO LAPIN TWIN WAGON R  <b>TOYOTA</b> CORSA,COROLLA II TERCEL CYNOS PASEO STARLET CAMI SPARKY HIACE  <b>OTHERS</b> INDUSTRIAL MACHINE  TRACTOR	(HC-E, HE-EG) (HD-EP, HE-EG) (3K-VET) (3K-VE)  (6VD1) (6VE1)  (K6A) (K6A) (K6A)  (3G83)  (K6A) (3G83)  (K10A) (M13A) (G15A/16A/13B) (J18A) (J20A) (J13B) (K6A) (K6A) (K6A) (K6A) (K6A) (K6A) (K6A) (K6A) (K6A) (K6A)  (4E-FE)  (4E-FE)  (4E-FE) (3K-VET) (3K-VE) RZH102/104 RZH112/114  (4BG1) (6VD1) (F2803)	98~00 98~ 00~ 00~  97~ 98~01  01~ 02~ 02~  98~  02~ 03~  97~00 00~02 97~00 97~98 96~00 98~00 01~ 01~ 01~ 02~ 02~ 03~ 01~ 01~  97~99  97~99  97~99 00~ 00~03 01~02  89~ 98~ 01~ 98~
	<b>021580-5300 ND</b>			

RECTIFIERS

# RECTIFIERS

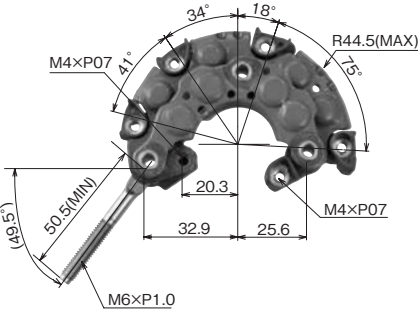
New-Era No.	Ref.No.	Application		
<b>D-092</b> <b>AC12V 60A</b> <b>AC24V 25A</b> 	<b>27357-72150</b> <b>27357-87708-000</b> <b>27357-76007-71</b> <b>31621-86510</b> <b>8-94455159-0</b>	<b>DAIHATSU</b> DELTA WIDE CHARADE	3FD1(1Y,2Y-J) G100(HC-E,CB37,CB70)	85~93 90~93
		<b>HONDA</b> VAMOS Z ACTY TODAY LIFE	HM1/2(E07Z) PA1(E07Z) (E05A,E07Z) JW1/2/3,JA1/2 (E05A,E07A,PZ1/2) JA4(E07A)	99, 03 98 88~94, 99 88~93 97~98
<b>ISUZU</b> RODEO, BIGHORN	(4ZC1,6VD1)	86,92~95		
<b>SUBARU(FUJI)</b> SAMBER	(EN07C,EN07L)	90~98		
<b>SUZUKI</b> GIMNY CULTUS	JB31,JA12/22(G13BA) (G13B)	93~97 86~88		
<b>TOYOTA</b> DYNA, TOYOACE LITEACE, TOWNACE	4FBL,4FB1/2 (1Y,2Y,3Y,3Y-P,27LPG) 3FDL,3FGL,3FG2 (1Y-J,2Y,2Y-J)	85~01 85~93		
HIACE,REGIUS CALDINA COROLLA,SPRINTER	(3Y,1RZ-E) ST19#(5E-FE) AE8#,AE9#,AE10# (2E,3E,5E-FE,4E-FE)	93~03 92~02 86~92,94~87		
CORSA, COROLLA2	L3#,L5# (2E,3E,5E-FE,4E-FE)	86~90,94~99		
CYNOS STARLET	(5E-FHE,4E-FE) EP7#,EP8#,EP9# (2E-LU/LJ,4E-FE)	95~99 86~99, 92		
CARINA CORONA	AT17#(3E) T17#(3E)	88~92 87~92		
<b>OTHERS</b> FORKLIFT	(1Z,2Z,11Z,13Z,14Z,1DZ,2J, 3F,4Y,4P,5K)	89~03		
EXCAVATOR	(1DZ,2Z,4Y,5K,1Z)	98~03		
EXCAVATOR	3SD15(1DZ)	90~94		
EXCAVATOR	4SD20/23/25(14Z)	97		
INDUSTRIAL MACHINE	2JD18/21/25(1Z)	89		
	<b>021580-3130 ND</b>			

RECTIFIERS



# RECTIFIERS

New-Era No.	Ref.No.	Application
<b>D-095</b>	<b>AC12V 80A</b>	<b>27357-55080</b>
		<b>27357-87102-000</b>
		<b>DAIHATSU</b> DELTA SR40N/50N (3S) 96~97 CR41J/42J/51J/52J (2C,3C) 96~98 KR42J (7K) 98 DELTAWIDE CB27V/21G (2C) 90~93 YB21G (3Y) 92~93 APPLAUSE A101S (HD-E1) 92~00 CHARADE G200S/201S/203S/213S (HC,HD,HE) 93~00 PYZAR G301G/303G/311G/313G (HD,HE) 96~00  <b>TOYOTA</b> MARK II /CHASER LX80/90/100 (2L-T,2L-TE) 88~99 YX80 (3Y) 88~95 SX80/80Y/90/100 (4S) 92~01 GX100/105 (1G) 96~01 CROWN LS130/130G/130W (2L-THE) 89~99 LS131/131H/141 (2L-T,2L-THE) 89~95 LS151/151H (2L-TE) 95~99 GS151/151H/GXS10 (1G) 95~02 GS151Z (1G) 98~01 YXS10/10H (3Y) 95~08 GS171/171W/GXS12 (1G) 01~07 COMFORT LXS11/11Y (2L-TE) 95~99 YXS11/11Y (3Y) 95~08 SXS11Y/13Y (3S,4S) 96~07 HIACE,REGIUS LH100G/102V/109V (2L,3L) 89~93 LH110G/113V/115B (2L,3L) 89~98 LH119V/123V/125B (3L) 89~98 LH129V/140G (2L,3L) 90~93 LH103V/113K (3L) 96~98 LH162V/168V/172K (5L) 98~04 LH172V/178V/182K (5L) 98~04 LH188K/184B/186B (5L) 98~04 RZH100G/101G/102V (1RZ,2RZ) 89~02 RZH111G/112K/112V (1RZ,2RZ) 96~03 RZH125B/183K (2RZ) 98~03 KZH100G/106G/106W (1KZ) 97~99 KZH110G/116G/126G (1KZ) 97~99 REGIUS TOURING RCH41W/47W (3RZ) 97~02 KCH40G/40W/46G/46W (1KZ) 97~99 GRANVIA RCH11W (3RZ) 95~96 KCH10W/16W (1KZ) 97~99 VCH10W/16W/22K/28K (5VZ) 97~05 URBAN SUPPORTER LY228K/270 (5L) 90~93 HILUX LN130G/130W (2L-TE) 90~93 LN147/167/172H (5L) 02~04 KZN130G/130W (1KZ) 93~95 VZN180W/185W (5VZ) 98~02 KZN185G/185W (1KZ) 98~00 RZN180W/185W (3RZ) 98~02 KDN185G/185W (1KD) 00~02 LANDCRUISER VZJ90W/95W (5VZ) 96~02 KZJ90W/95W (1KZ) 96~00 KDJ90W/95W (1KD) 00~02 LITE ACE/TOWN ACE CM30G/40G/41V/51/55 (2C) 90~99 CM65/CR27V/36V (2C) 90~99 SR40G/50G (3S) 96~01 YR21G (3Y) 93~96 CM70/75/85 (3C) 99~04 CR41V/42V/51V/52V (2C,3C) 96~04 KM70/75/85 (7K) 98~07 KR42V/52V (7K) 04~07 CM40G/CM65 (2C) 88~90 CR21G/28G/30G/37G (2C) 90~92 CR21G/28G/30G/37G (2C) 88~92 ESTIMA EMINA CXR10G/11G/20G/21G (3C-T) 92~99 COROLLA/SPRINTER AE92/95/95G (4A) 88~91 AE91/91G (5A) 88~91 EE101/102V/103V (4E) 91~93 EE104G/111 (4E,5E) 94~00 AE100/100G/101 (5A,4A) 91~97 AE101G/111/109V/110 (5A,4A) 95~02 CE100/100G/104/106V (2C) 93~98 CE108G/109V/110/114 (2C,4A,5A) 93~98 CE105V/113/116 (3C) 98~02
	<b>CONTINUED</b>	<b>021580-4630 ND</b>

RECTIFIERS

# RECTIFIERS

New-Era No.	Ref.No.	Application
<b>D-095</b>	<b>AC12V 80A</b>	
	27357-55080 27357-87102-000	
		COROLLA/SPRINTER CE101G/102G/107V (3C) 98~02 SPACIO AE111N,115N (4A,7A) 97~01 CORONA AT170/175 (5A,4A) 88~92 ST190/191/195 (3S,4S,4A) 92 CT190/190Y/195 (2C) 92~96 ST190/190Y/191/195 (3S,4S) 92~96 AT190/210/211/215 (4A,5A,7A,3S) 92~91 CT210/211/215/216 (2C,3C) 96~01 ST215 (3S) 97~01 SCEPTER SXV10/15/15W (5S) 92~96 VCV10/15/15W (3VZ) 92~96 CAMRY/VISTA VZV20 (1VZ) 88~90 SV30/32/35 (3S,4S) 92~94 VZV32/33 (4VZ) 92~94 CV30/43 (2C,3C) 92~98 SV40/41/42/43 (3S,4S) 94~98 SXV20 (5S) 96~98 VISTA ZZV50/50G (1ZZ) 98~03 SV55/55G (3S) 98~02 MR2 SW20 (3S-GE) 89~91 ESTIMA TCR10W/11W/20W/21W (2TZ) 90~99 CARINA AT171 (4A) 88~92 AT170/170G/175 (5A,4A) 88~92 CT190/195 (2C) 92~96 CT210/211/215 (2C,3C) 96~01 AT190/191/192 (4A,5A,7A) 92~96 AT211/212 (5A,7A) 96~01 ST215 (3S) 96~01 CORSA/COROLLA II EL31/NL40/50 (3E,1N) 88~94 EL41/43/45/53/55 (3E,4E,5E) 90~99 STARLET EP82/85/NP80/90 (4E,1N) 89~99 EP91/95 (4E) 98~99 SERA EXY10 (5E) 90~95 CYNOS EL44/54/54C (5E) 91~99 RAUM EXZ10/15 (5E) 97~03 WINDOM VCV10/11 (3VZ,4VZ) 91~96 CALDINA CT190G/196V/198V (2C) 92~98 CT197V/199V (3C) 98~02 ET196V (5E) 92~02 ST190G/191G/195G/198V (3S,4S,7A) 92~97 ST210G/211G/215G (3S,7A) 97~02 RAV4 SXA10G/11G/10W/11W (3S) 94~00 SXA10C/15G/16G (3S) 97~00 VITZ/PLATZ SCP10/11 (1SZ) 99~05 NADIA SXN10/10H/15/15H (3S) 98~02 DYNA/TOYOACE LY220/230/240V (5L) 01~04 LY270/280/290V (5L) 01~04 YR21G (3Y) 92~93
	021580-4630 ND	

# RECTIFIERS

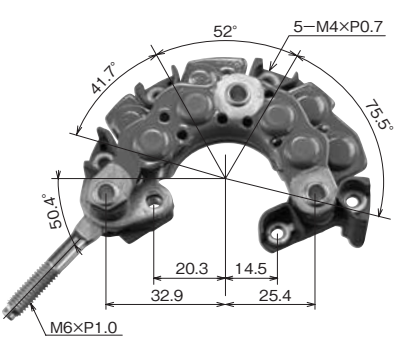
New-Era No.	Ref.No.	Application			
D-096	AC12V 35A	27357-87201-000	DAIHATSU		
		27357-7800-71	MIRA	L70S/70V/71V (EB)	85~90
	15881-64851 185446229 6281-229-029-0 X02158-03080	L500S	(EF)	95~98	
		L600S	(EF)	95~98	
		L100S/100V	(EB)	86~90	
		S80C/80P/80V/81C	(EB)	86~90	
		S81P/81V	(EB)	86~90	
		S100C/CT/P/S110C/CT/P	(EF)	94~98	
		S82C/P/S83C/P	(EF)	90~94	
		K100P	(EF)	96	
		MIDJET2			
		YANMAR	ENGINE	(3TNA81) 88~ (3TNE78A) 98~ (3TNV84) 03~ 92	
		KUBOTA	AF33 ENGINE (A28) ENGINE (D1105) ENGINE (V2203) 95~ (V1505) 92~ (Z402) 00~ (V2403) 04~		
		IHI	ENGINE (S753) 93~ (S753C) 03~ (S773L) 01~		
		ISEKI	ENGINE (E255-G,E262-G,E269-B) 87~ (E310-0B,E3112B,E374-G) 87~ (380B,E390-B,E393B,E393GH) 87~ (E3CE-B,E3CF-B) 87		
			TG (E3CDB13) 98		
			TF (E3CFB02) 99~		
			KHP (N844) 95~		
		OTHERS			
		EXCAVATOR			
		TOYOTA	3SDK4/5/6/7/8 (3TN,1DZ) 92~97 4SDK3/4/ (3TN,3TNE) 97~ 4SDKL3/4/5/6 4SDDL6 (D1105) 97~		
		FORKLIFT			
		TOYOTA	5FD10/14/15/18/20/23/25 (V1502,VT1502) 86~89 5FDL10/14/15/18/20/23/25 (V1502,VT1502) 86~89 5FG10/14/15/16/18/20/23 (4P,4Y) 86~89 5FG25/28/30 (4P,4Y) 86~89 5FGL10/14/15/18/20/23/25 (4P) 86~89 2FG7/9/FGL7/9/ (ED,EB) 92~ 3FG5/7/9 3FGL5/7/9/FG5 (AB) 91~97		
		INDUSTRIAL MACHINERY			
		KOMATSU	FD20-11/20DC-11/ (4D95S) 88~ 20SDC-11 FD20ST-11/20T-11/ (4D95S) 88~ 20WC-11 FD30H011 (4D95L) 88~ ESG45/65 (4D95LE-2) 99~		
		TRACTOR			
		ISEKI	TRACTOR (E3AD1,E3AE1,E3AF1) 87~ (E3AG1,E4DAB,E4DBB) 87~ (E4DCB,E4DDB,E4DDT) 87~ (E3CC-A) 91~ (E3CD-A/B/T) (E3CE-A/B/G, E3CF-B) 91~		
		021580-3080 ND			

RECTIFIERS





# RECTIFIERS

RECTIFIERS

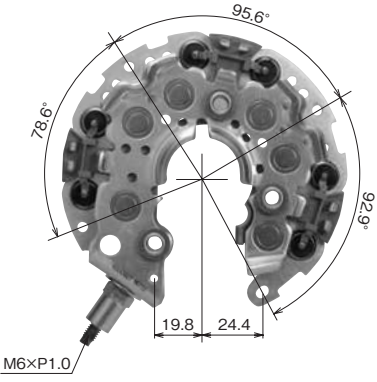
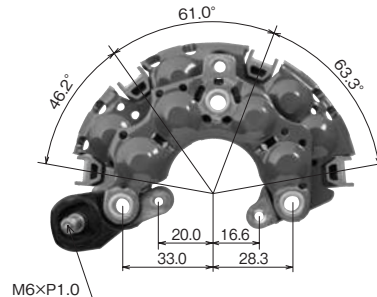
New-Era No.	Ref.No.	Application				
<b>D-097</b> <b>AC12V 150A</b> 	<b>27357-20270</b> <b>27357-30070</b> <b>27357-58460</b>  <b>021580-6370 ND</b> <b>021580-7980 ND</b> <b>021580-9620 ND</b> <b>021580-9370 ND</b>	CAMRY	ACV30/35	(2AZ-FE)	03~06	
				ACV40/45	(2AZ-FE)	06~11
		MARK X ZIO	ANA10/15	(2AZ-FE)	07~	
			GGA10	(2GR-FE)	07~	
		HILUX	GRN215W	(1GR-FE)	05~09	
		IST	ZSP110	(2ZR-FAE)	07~10	
		A URIS	ZRE152H/154H	(2ZR-FE/FAE)	06~	
		COROLLA RUMION	ZRE152N/154N	(2ZR-FE/FAE)	07~	
		COROLLA	ZRE142/142G/144/144G	(2ZR-FE/FAE)	06~12	
		CROWN	TSS10/10H	(1TR-FPE)	10~	
			GRS180/200/201	(4GR-FSE)	03~	
			GRS181/182/202/203	(3GR-FSE)	03~	
			GRS204	(2GR-FSE)	05~	
		CONFORT	TSS11/11Y	(1TR-FPE)	10~	
		ALPHARD/VELLFIRE	GGH20W/25W	(2GR-FE)	08~	
	ANH10W/15W/20W/25W	(2AZ-FE)	05~			
	MNH10W/15W	(1MZ-FE)	03~08			
QUICK DELIVERY	XKU280K	(N04C-TN)	06			
<b>LEXUS</b>						
IS	GSE20/25	(4GR-FSE)	05~			
	GSE21	(2GR-FSE)	05~			
RX	AGL10W	(1AR-FE)	10~			
	GGL10W/15W/16W	(2GR-FE)	09~			
GS	GRS191/196	(2GR-FSE)	05~11			
<b>HINO</b>						
DUTRO	BZU300M/300X/340M	(1BZ-FNE/FPE)	03~07			
	XZU412M	(15B-LPG)	02~03			
	TRU300M/300X/340M/500M	(2TR-FE)	07			
<b>DAIHATSU</b>						
ALTIS	ACV40N/45N	(2AZ-FE)	06~10			
<b>D-098</b> <b>AC12V 80A</b> <b>AC24V 35A</b> 	<b>27357-74260</b>  <b>021580-4670 ND</b>	<b>KOMATSU</b>				
		EXCAVATOR	PC-200	(SAA6D102)	03~	
		EXCAVATOR	PC78US-6	(4D95LE)	02~	
		WHEEL LOADER	WA100-5	(SAA4D102)	03~	
		<b>TOYOTA</b>				
		CELICA	ST182/183/183C	(3S-GE)	89~93	
			ST185	(3S-GTE)	89~91	
			ST185H	(3S-GTE)	90~93	
			ST202/203	(3S-FE)	93~99	
			ST202/202C	(3S-GE)	93~99	
			ST205	(3S-GTE)	94~99	
		MR2	SW20	(3S-GE)	91~99	
		CARINA	ST170/170G	(4S-FE)	92	
			ST180/181	(4S-FE)	92~93	
			ST182/183	(3S-GE/FE)	89~93	
	ST190	(4S-FE)	92~94			
	ST195	(3S-FE)	92~96			
	ST200	(4S-FE)	93~97			
	ST201	(4S-FE)	93~94			
	ST202/203	(3S-FE)	93~97			
	ST202/205	(3S-GE)	93~98			
CURREN	ST206/207	(3S-FE)	94~98			
	ST206	(3S-GE)	94~98			
	ST208	(4S-FE)	95~98			
CORONA	ST180/181	(4S-FE)	92~93			
	ST182/182A/183	(3S-GE)	89~93			
	ST200	(4S-FE)	93~98			
	ST201	(4S-FE)	93~94			
	ST202/203	(3S-FE)	93~98			
	ST202/205	(3S-GE)	93~98			
CYNOS	EL52C	(4E-FE)	98~99			
CAMRY/VISTA	SV30	(4S-FE)	92			
	SV32/33/35	(3S-FE)	92			
<b>ISUZU</b>						
GEMINI			91~93			

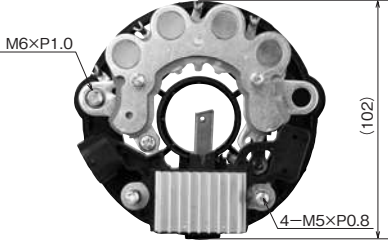
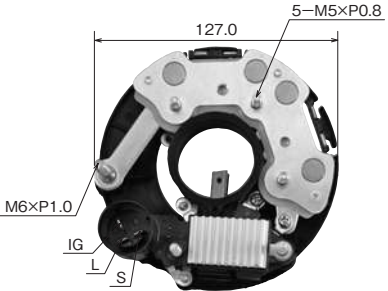
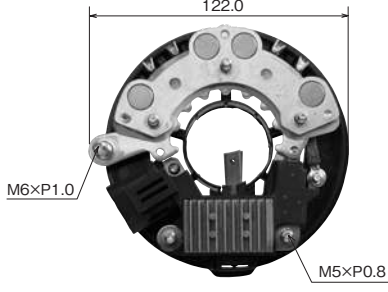
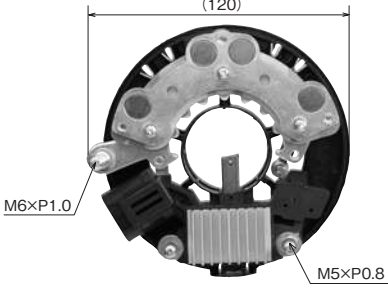

# RECTIFIERS

New-Era No.	Ref.No.	Application
<b>DIVR-860600 AC12V 65A</b> 	<b>23124-72B01</b>          <b>L165G-6308 HI</b> <b>L165G-3308 HI</b>	<b>NISSAN</b> CUBE MARCH Z10(CG13DE) K11(CG10/CG13) 97~99 97~99  (IVR-860 + D-600 with back plate)
<b>DIVR-864607 AC24V 60A</b> 	<b>8-97111263-0</b>          <b>L250G-2308 HI</b>	<b>ISUZU</b> ELF NKR,NPR(4HF1,4HG1,4HJ1) 97~04  <b>MAZDA</b> TITAN WG64,WG3(4HG1,4HF1) 95~97  (IVR-864 + D-607 with back plate)
<b>DIVR-865610 AC24V 50A</b> 	<b>8-97148169-1</b>          <b>L250G-5308 HI</b>	<b>ISUZU</b> ELF NKR,NPR(4HF1,4HG1,4HJ1) 97~  (IVR-865 + D-610 with back plate)
<b>DIVR-866611 AC24V 50A</b> 	<b>8-97253577-0</b>          <b>L250G-13081 HI</b>	<b>ISUZU</b> ELF NKR,NPR(4HF1,4HG1,4HJ1,4HK1,4HL1) 00~  (IVR-866 + D-611 with back plate)