

Parallel Mechanical Gripper

# HP09L Series

Long Stroke Type

## Selectable Gripping Force

L: Low  
M: Medium  
H: High

**Long  
Stroke**

External Force

Through  
Mounting Hole

Positioning Hole

**High Rigidity  
High Accuracy**

Excellent  
**CENTERING Accuracy**

◆  $\pm 0.07\text{mm}$  or less

## Use of **LINEAR GUIDE**

- ◆ Withstand load, withstand moment (high rigidity)
- ◆ High accuracy (repeat accuracy:  $\pm 0.01\text{ mm}$  or less)
- ◆ Gripping at a long point and overhang gripping are available.

HP09L Series

Parallel Mechanical Gripper (Long Stroke Type)

# HP09L Series

## Model Code No.

**HP09L - 10 - L**

Series Name

Nominal diameter

8  
10  
16  
20

Gripping Force

L: Low  
M: Medium  
H: High

\*Please feel free to consult us about the grip forces (spring forces) other than the ones specified on the left.

## Internal Structure Diagram

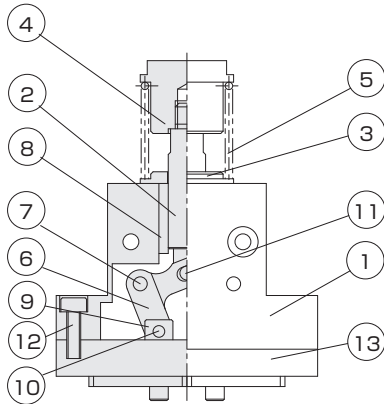

## Parts List

NO	Name	Material
1	Main Body	Aluminum Alloy
2	Piston Rod	Stainless Steel
3	Pressure Cover	Aluminum Alloy
4	Pressure Cover	Carbon Tool Steel
5	Spring	Spring Steel
6	Action Lever	Carbon Tool Steel
7	Fulcrum Pin	Carbon Tool Steel
8	Metal	Oil-impregnated Sintered Bearing
9	Knuckle	Stainless Steel
10	Roller	Carbon Steel
11	Roller	Carbon Steel
12	Hexagon Socket Head Bolt	Carbon Tool Steel
13	Bearing	Stainless Steel

## Specifications

Elastic Body to be Used	Compression spring
Action Type	Single Acting Normally Close (External force drive at opening)
Operating Temperature [°C]	0~120
Lubrication	Required (Sliding parts of the machine)
Maximum Operating Cycle [Cycle/min]	180
Centering Accuracy [mm]	±0.07
Repeat Accuracy [mm]	±0.01
Applicable Switch	Not mountable

Action Type	Model	Nominal diameter [mm]	Opening/Closing Stroke [mm] <sup>Note)3</sup>	Gripping Force (At Closing) [N]	<sup>Note)1</sup> Extrinsic Force [N]	Allowable Extrinsic Force [N]	Product Mass [g]	Outside Dimensions (T x W x L) [mm]	<sup>Note)2</sup> Lever Ratio
Single Acting Normally Close	HP09L-8-L	8	8 (7.4~10.6)	1.6	8	30	34	13×26×42.8	1:2
	HP09L-8-M			2.5	12				
	HP09L-8-H			4.3	17				
	HP09L-10-L	10	12 (10.9~15.1)	3.4	17	50	100	20×45×62.1	1:2
	HP09L-10-M			4.5	21				
	HP09L-10-H			7.2	36				
	HP09L-16-L	16	16 (15.3~18.2)	4.4	19	130	186	25×56×69.8	1:2.2
	HP09L-16-M			6.4	32				
	HP09L-16-H			11.0	49				
	HP09L-20-L	20	22 (21.1~24.5)	6.5	32	210	366	32×73×86.6	1:1.9
	HP09L-20-M			8.3	40				
HP09L-20-H	12.0			60					

Note 1): Extrinsic force is an external force required to open the levers completely by overwhelming the spring force in the closing direction.

Note 2): The lever ratio is the "Extruded Distance (how much the rear rod is extruded) and the "Lever Opening Distance (Lever Opening Distance at that time) (both sides) expressed in "Extruded Distance: Lever Opening Distance".

Note 3): The opening/closing stroke is a reference value. Values in the parentheses are measured values.

## Allowable Load and Allowable Moment

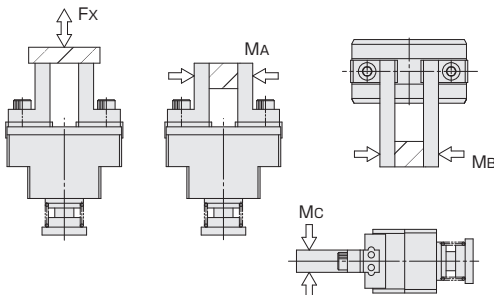

Model	Load and Moment Fx [N]	MA [N·m]	MB [N·m]	Mc [N·m]
HP09L-8	12	0.04	0.04	0.08
HP09L-10	50	0.4	0.4	0.8
HP09L-10	120	1	1	2
HP09L-20	200	1.5	1.5	3

# HP09L Series

## Effective Gripping Force

— When the levers are full open  
 - - - When the levers are full closed

HP09L Series

Parallel Mechanical Gripper (Long Stroke Type)

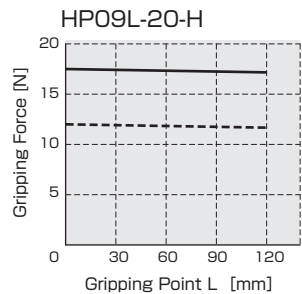
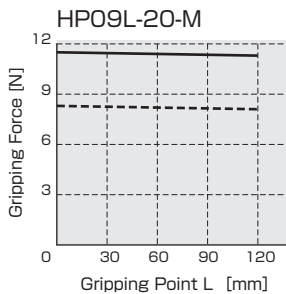
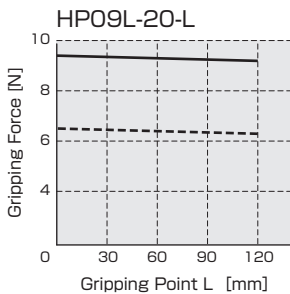
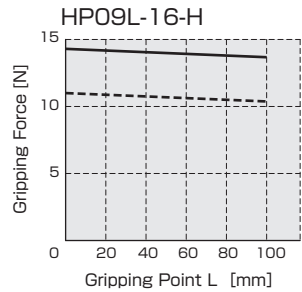
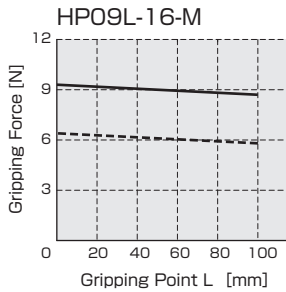
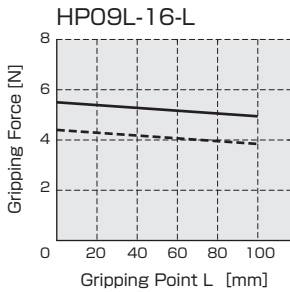
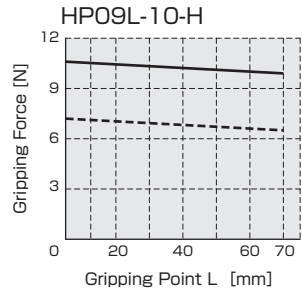
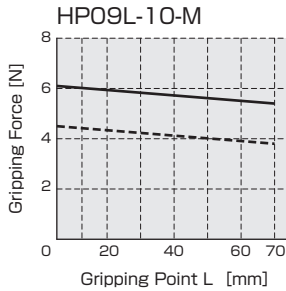
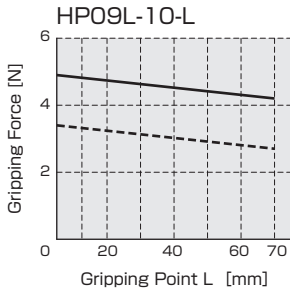
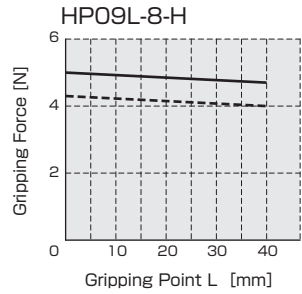
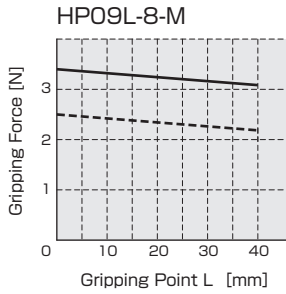
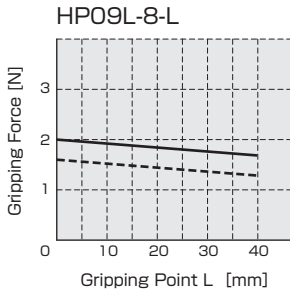

## Gripping Point Limit Range

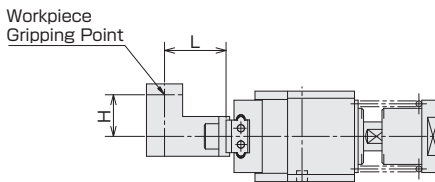
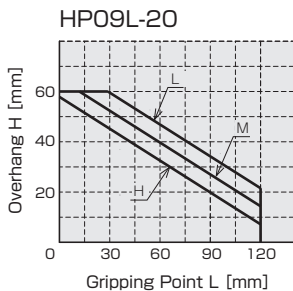
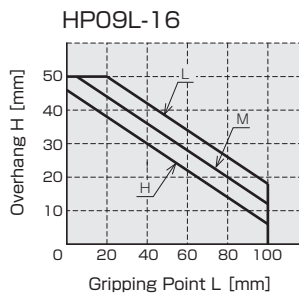
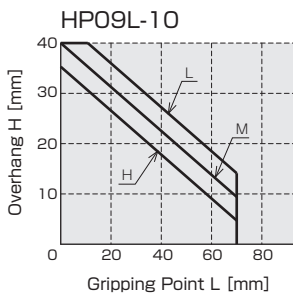
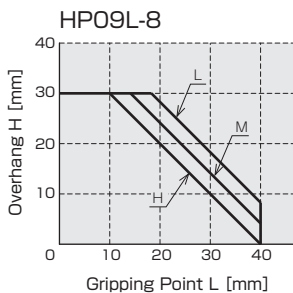

## Main Body Mounting Example

- 1** When the through-hole of the main body is used

(For  $\phi 16$  and  $\phi 20$ , the bolt head does not protrude from the main body.)

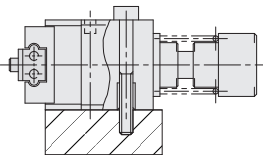

- 2** When the mounting screw on the back side of the through-hole is used

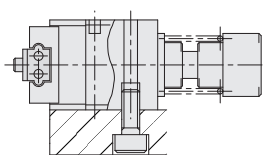

- 3** When the mounting screw on the bottom face of the main body side is used

(Excluding  $\phi 8$ )

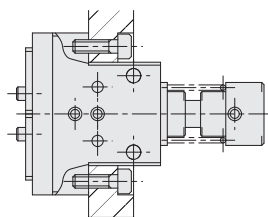

## Dimensions HP09L-8-□

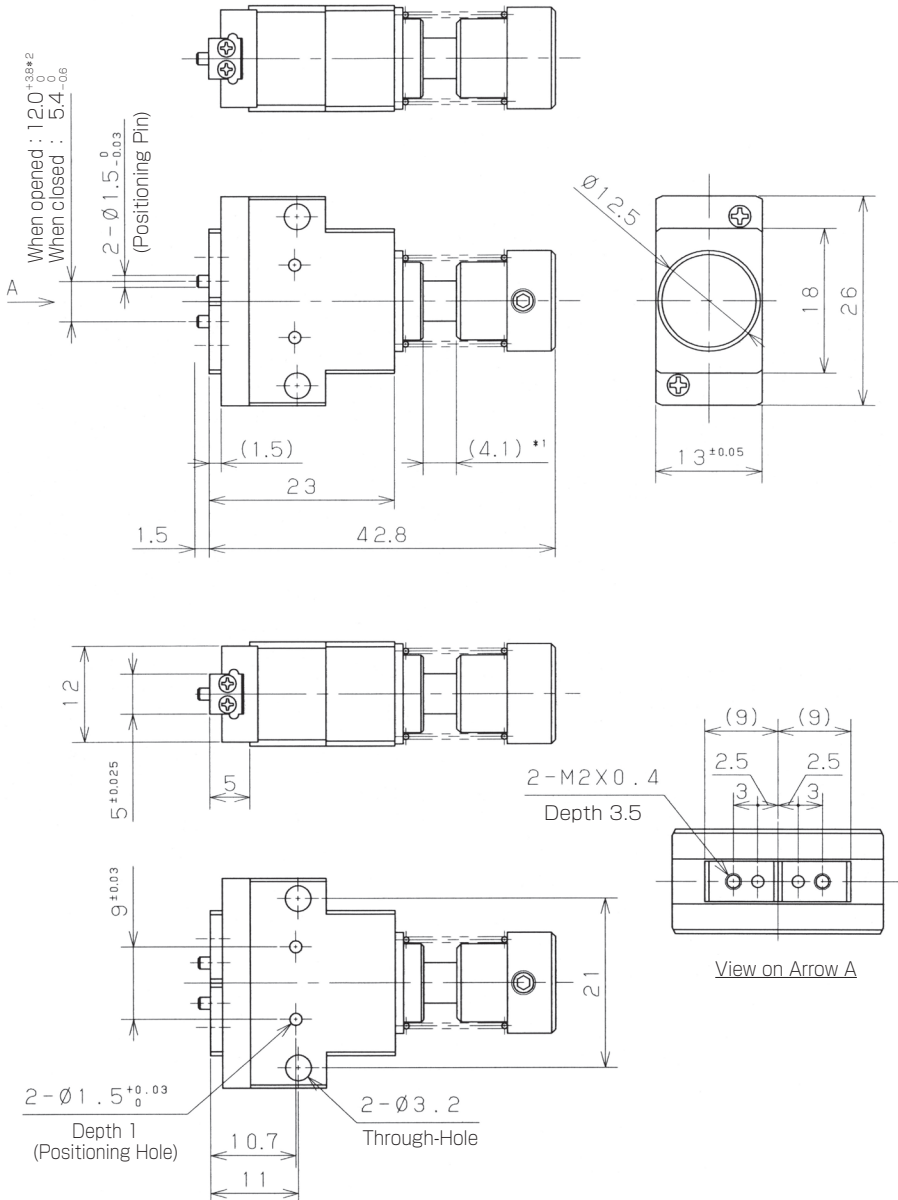

Note) · The allowable extrusion force shall be within the specified range in use.  
 · Do not hit the cam and the dog against the pressure cover in use.

- \* 1) This dimension allows extrusion. See "Lever Ratio" for the lever opening distance for the extrusion distance.
- \* 2) This is a dimension at the maximum extrusion.

Dimensions HP09L-10-□

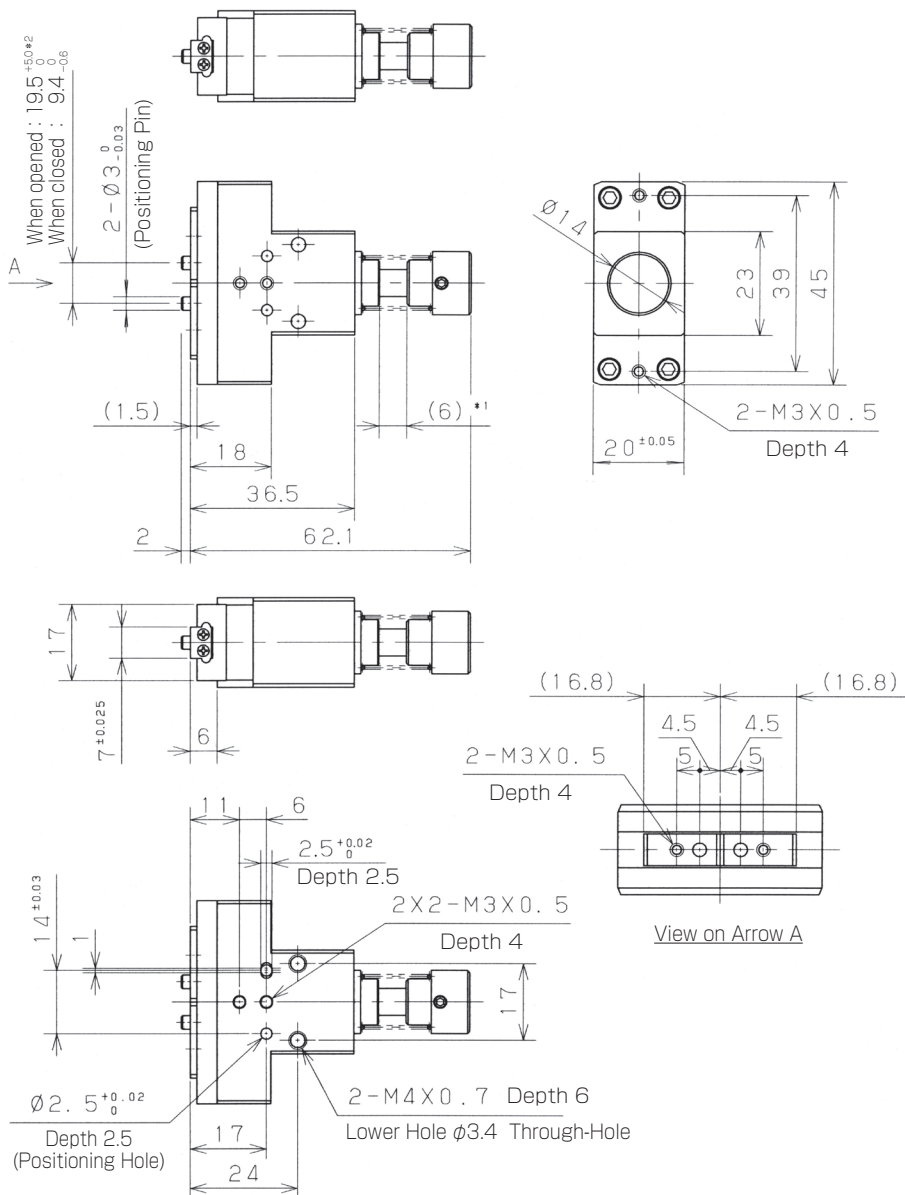

HP09L Series

Parallel Mechanical Gripper (Long Stroke Type)

Note) · The allowable extrusion force shall be within the specified range in use.  
 · Do not hit the cam and the dog against the pressure cover in use.

- \* 1) This dimension allows extrusion. See "Lever Ratio" for the lever opening distance for the extrusion distance.
- \* 2) This is a dimension at the maximum extrusion.

## Dimensions HP09L-16-□

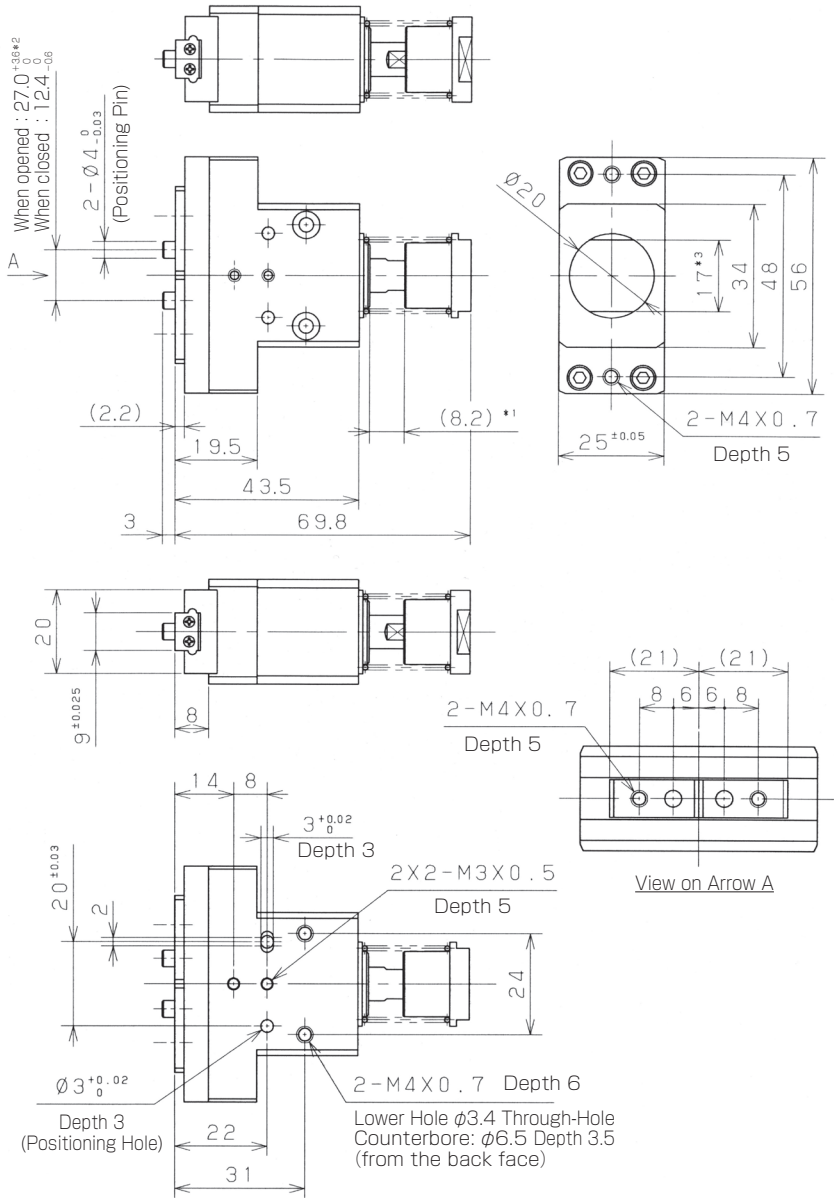

Note) · The allowable extrusion force shall be within the specified range in use.

· Do not hit the cam and the dog against the pressure cover in use.

\* 1) This dimension allows extrusion. See "Lever Ratio" for the lever opening distance for the extrusion distance.

\* 2) This is a dimension at the maximum extrusion.

\* 3) This is used for rod tightening, so it is different from the actual position.



Dimensions **HP09L-20-□**

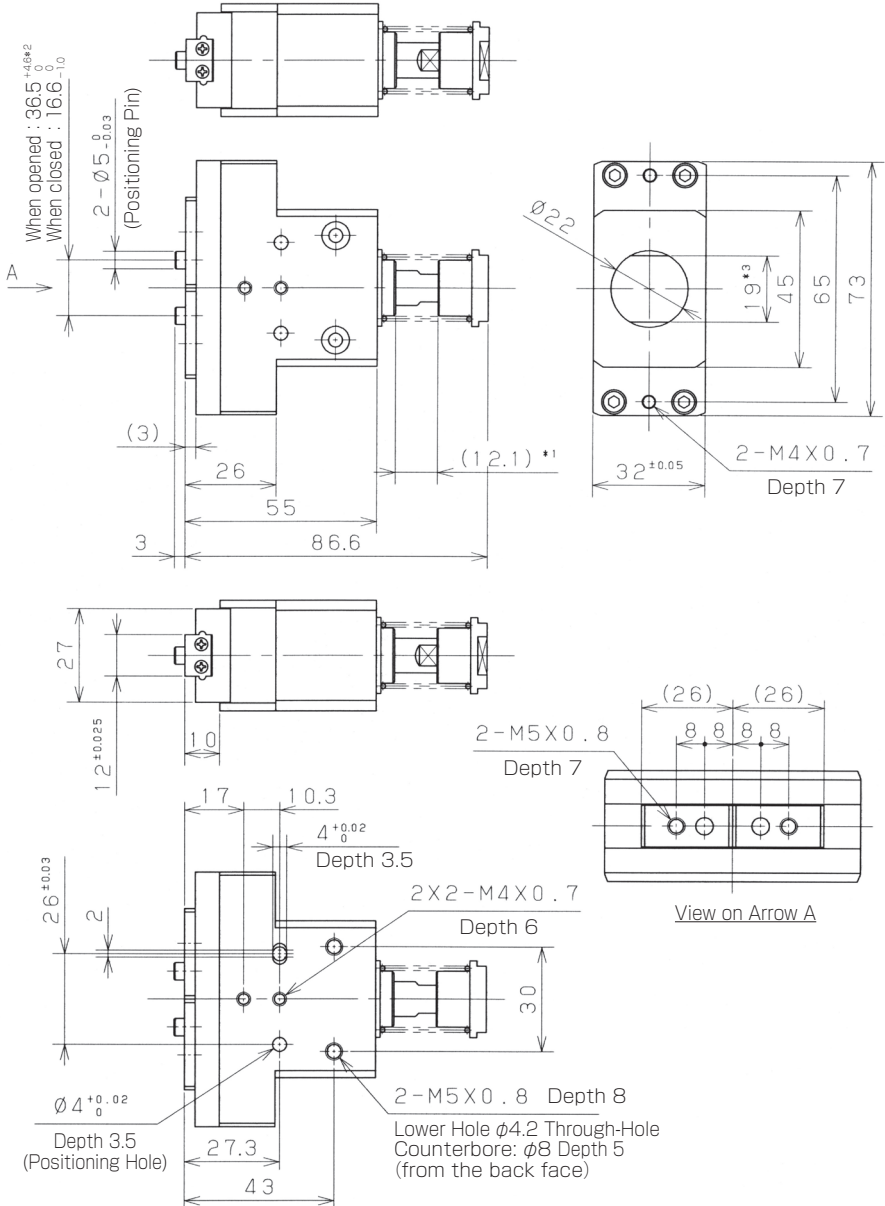

HP09L Series

Parallel Mechanical Gripper (Long Stroke Type)

Note) - The allowable extrusion force shall be within the specified range in use.  
 - Do not hit the cam and the dog against the pressure cover in use.

\* 1) This dimension allows extrusion. See "Lever Ratio" for the lever opening distance for the extrusion distance.

\* 2) This is a dimension at the maximum extrusion.

\* 3) This is used for rod tightening, so it is different from the actual position.