

JAN, 2022

Dear Valued Partners

New-Era Co., Ltd
Sales Department, Pneumatic Group

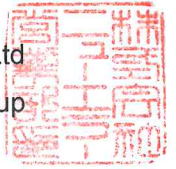

ANNOUNCEMENT OF STANDARD PRICE REVISION AND
APPEARANCE ALTERATION FOR PPT-GT6Y SERIES

We sincerely appreciate for your continued co-operation. This is to announce to all our customers. Due to the forced circumstances, we need to revise standard price for only 1 series of PPT-GT6Y series this time. We have been tried to keep standard price, but now it is difficult situation to maintain the current standard price with only our efforts due to bankruptcy of suppliers for those years. Your thoughtful understanding is highly appreciated.

Also, a part of appearance will be altered. Although we were using different body for TP, PP, and LP type, they will be integrated into one common body. There will be no effect for the quality and performance of product due to only alteration of appearance caused by integration. Appearance Alteration Drawing is attached.

Even though with this difficult situation, we hope you could support our products from now on too.

1, TARGET SERIES

PPT(S)-GT6Y SERIES

MODEL CODE EXAMPLE) PPTS-**GT6Y**-5-TPQR,PPT-**GT6Y**-10-LP,PPTS-**GT6Y**-PP, etc

2, APPEARANCE ALTERATION AND POINTS

PLEASE REFER ATTACHED DOCUMENT

3, TIMING OF APPEARANCE ALTERATION

AFTER SELLING CURRENT COMPONENTS OUT

4, DATE OF PRICE REVISION

FROM MAR 1st, 2022 30%UP OF STANDARD PRICE

TP Current Product

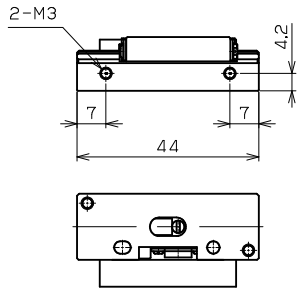

PP Current Product

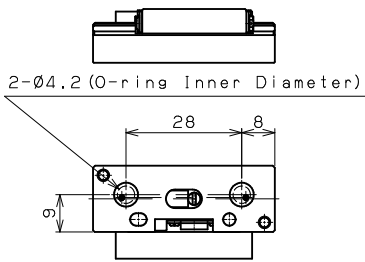

LP Current Product

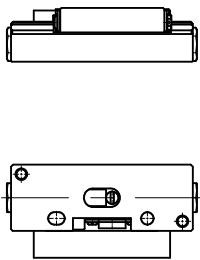

5 Stroke

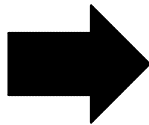

TP/PP/LP
Common Parts Body

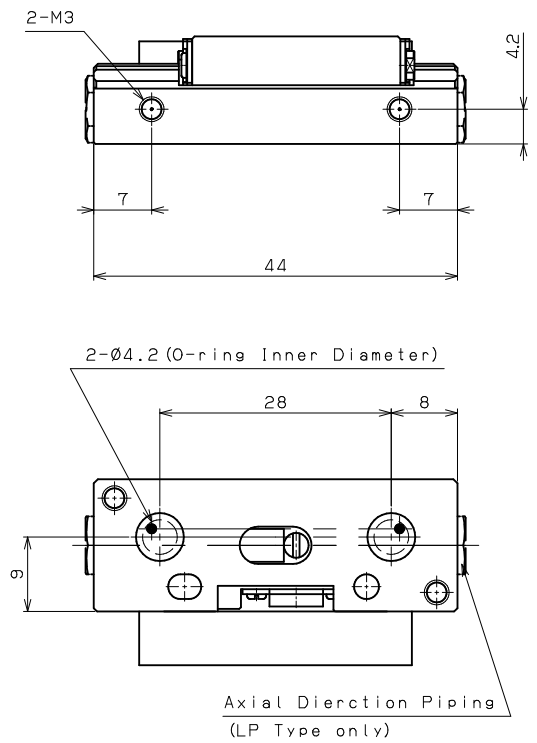

TP Current Product

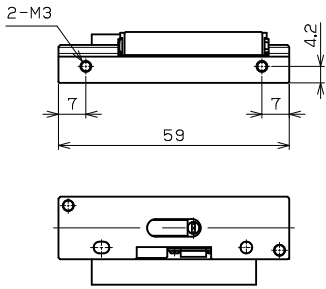

PP Current Product

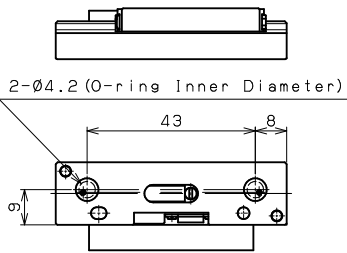

PP Current Product

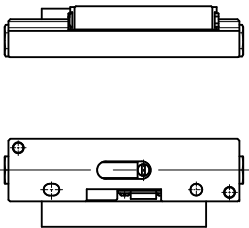

10 Stroke

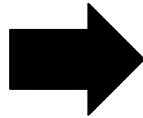

TP/PP/LP
Common Parts Body

