











# BATTERY RELAYS





| New-Era No.  | Ref.No.   | Application  |
|--|---|--|
| <b>BR-153</b><br><br>12V<br>⊖ Cut   | BS-1 AE   | <b>KOMATSU</b><br>KOMATSU INTERNATIONAL<br>MITSUI ZOSEN<br>NIIGATA TEKKO<br>INDUSTRIAL USE |
| <b>BR-155</b><br><br>12V<br>⊕ Cut   |   | <b>KOMATSU</b><br>KOMATSU INTERNATIONAL<br>INDUSTRIAL USE                                  |
| <b>BR-159</b><br><br>12V<br>⊕ Cut  | BS2-121   | UNIVERSAL  |
| <b>BR-160</b><br><br>12V<br>⊕ Cut | BS2-141   | UNIVERSAL  |
| <b>BR-253</b><br><br>24V<br>⊖ Cut | 8279-0008<br>8279-0018<br>8279-0021<br>8279-0033<br>8279-0043<br>BS-E <sub>1</sub> AE | <b>ISUZU</b><br>BUS, TRUCK<br>TX541, 542, 552<br>BR351, 751<br>BA741, BC161<br>62~68       |

BATTERY RELAYS

# BATTERY RELAYS





| New-Era No.  | Ref.No.  | Application   |
|--|--|---|
| <b>BR-257</b><br><br>24V<br>⊕ Cut   | 60713-50450<br>60713-50451<br><br>BS-L AE                  | <b>HINO</b><br>TRUCK<br>KC320, KF721, KM300,<br>TC311, ZM711<br>69~72 |
| <b>BR-259</b><br><br>24V<br>⊕ Cut   | 25613-90008<br><br>BS-N AE                                 | <b>NISSAN(DIESEL)</b><br>UD TRUCK<br>6TWCTC80/81<br>69~               |
| <b>BR-261</b><br><br>24V<br>⊕ Cut  | 8279-0052<br>8279-0055<br>8279-0065<br><br>BS-H AE<br>Q AE | <b>ISUZU</b><br>BUS, TRUCK<br>BH20P, TX, TD<br>69~72                  |
| <b>BR-262</b><br><br>24V<br>⊕ Cut | 8255-0008<br>60713-52330<br><br>BS-262 AE                  | <b>ISUZU</b><br>TRUCK<br>TX, TD<br>73~                                |
| <b>BR-263</b><br><br>24V<br>⊕ Cut | 8255-0009  | <b>ISUZU</b><br>BUS, TRUCK<br>TX, TD, BU<br>73~                       |

# BATTERY RELAYS

| New-Era No.  | Ref.No.   | Application  |
|--|---|--|
| <b>BR-265</b><br><br>24V<br>⊕ Cut   | 25613-Z2000<br>25613-Z2002<br><br>BS-312 AE           | NISSAN(DIESEL)<br>UD TRUCK<br>79~                            |
| <b>BR-266</b><br><br>24V<br>⊖ Cut   | 08088-10000   | KOMATSU  |
| <b>BR-270</b><br><br>24V<br>⊕ Cut  | 8-94379543-0<br>8-94379543-1<br>X4255762<br><br>BS982 | ISUZU<br>HITACHI   |
| <b>BR-271</b><br><br>24V<br>⊕ Cut | 25510-Z6000<br><br>BS-082-2                           | NISSAN   |
| <b>BR-272</b><br><br>24V<br>⊕ Cut | 25510-00Z00<br><br>B8024-746                          | NISSAN(UD TRUCK)<br>BIG THUMB<br>TRUCK (6t)<br>CW520, CKB450 |

BATTERY RELAYS

# BATTERY RELAYS

| New-Era No.  | Ref.No. | Application                   |
|--|---------|-------------------------------|
| <b>BR-630</b> <b>24V</b><br>            |         | <b>KOMATSU</b><br>BR-262 TYPE |
| <b>BR-631</b> <b>24V</b><br><br>⊕ Cut   |         | <b>KOMATSU</b><br>BR-265 TYPE |
| <b>BR-632</b> <b>24V</b><br><br>⊕ Cut  |         | <b>KOMATSU</b>                |
| <b>BR-633</b> <b>24V</b><br><br>⊕ Cut |         | <b>KOBELCO</b>                |

# BATTERY RELAYS

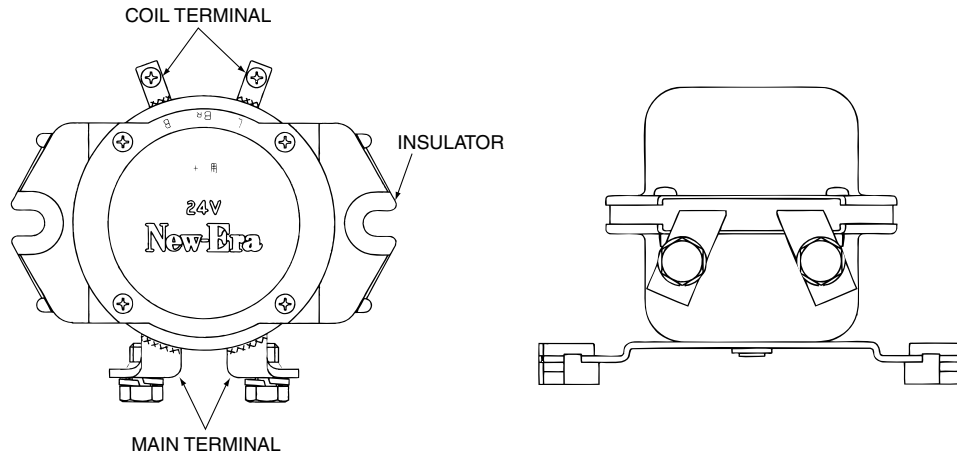

| New-Era No. | Cut | Rated Voltage |          | Rated Current  |            | Insulator on bracket | Shape of main terminal | Type of circuit | Remarks                         |
|-------------|-----|---------------|----------|----------------|------------|----------------------|------------------------|-----------------|---------------------------------|
|             |     | Starting      | Charging | Within 0.1sec. | Continuous |                      |                        |                 |                                 |
| BR-153      | -   | 12V           | 14V      | 1000A          | 40A        | without              | A                      | 1               |                                 |
| BR-155      | +   | 12V           | 14V      | 1000A          | 40A        | without              | A                      | 2               |                                 |
| BR-159      | +   | 12V           | 14V      | 1000A          | 100A       | with                 | B                      | 6               |                                 |
| BR-160      | +   | 12V           | 14V      | 1000A          | 100A       | with                 | B                      | 4               |                                 |
| BR-253      | -   | 24V           | 28V      | 1000A          | 120A       | without              | A                      | 1               |                                 |
| BR-257      | +   | 24V           | 28V      | 1000A          | 120A       | without              | A                      | 3               |                                 |
| BR-259      | +   | 24V           | 28V      | 1000A          | 35A        | without              | C                      | 2               |                                 |
| BR-261      | +   | 24V           | 28V      | 1000A          | 120A       | with                 | B                      | 2               |                                 |
| BR-262      | +   | 24V           | 28V      | 1000A          | 35A        | with                 | B                      | 4               | one lead wire on coil terminal  |
| BR-263      | +   | 24V           | 28V      | 1000A          | 35A        | with                 | B                      | 4               | two lead wires on coil terminal |
| BR-265      | +   | 24V           | 28V      | 1000A          | 35A        | with                 | C                      | 6               |                                 |
| BR-266      | -   | 24V           | 28V      | 1000A          | 35A        | without              | A                      | 8               |                                 |
| BR-270      | +   | 24V           | 28V      | 1000A          | 100A       | with                 | C                      | 4               |                                 |
| BR-271      | +   | 24V           | 28V      | 1000A          | 100A       | with                 | C                      | 6               |                                 |
| BR-272      | +   | 24V           | 28V      | 1000A          | 100A       | with                 | C                      | 6               |                                 |
| BR-630      | +   | 24V           | 28V      | 1000A          | 100A       | with                 | B                      | 5               |                                 |
| BR-631      | +   | 24V           | 28V      | 1000A          | 100A       | with                 | C                      | 5               |                                 |
| BR-632      | +   | 24V           | 28V      | 1000A          | 120A       | with                 | B                      | 9               |                                 |
| BR-633      | +   | 24V           | 28V      | 1000A          | 120A       | with                 | C                      | 9               |                                 |

## BATTERY RELAYS

### SHAPE OF MAIN TERMINAL

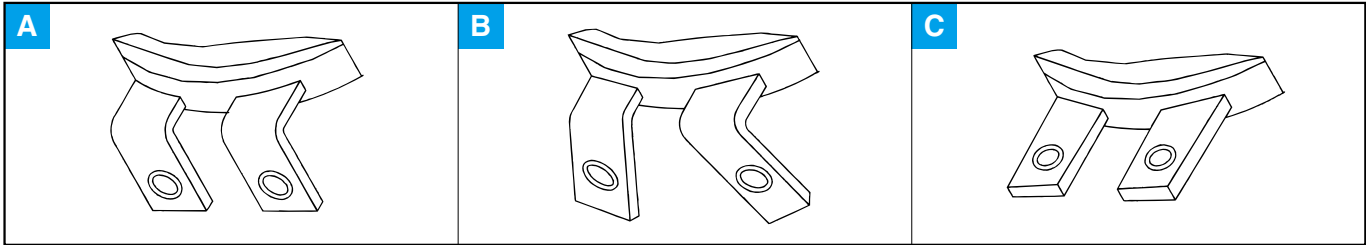

### TYPE OF CIRCUIT

