

# FUEL PUMPS

FUEL PUMPS



## INTANK TYPE

NFP-001JA / NFP-001JB  
 NFP-002JA / NFP-002JB  
 NFP-003JA / NFP-003JB  
 NFP-004JA / NFP-004JB / NFP-004JC  
 NFP-004JD / NFP-004JE  
 NFP-005JA / NFP-006JA  
 NFP-007JA / NFP-008JA  
 NFP-009JA / NFP-010JA  
 NFP-011JA / NFP-011JB  
 NFP-012JA / NFP-013JA

## OUTSIDE TYPE

NFP-100J1 / NFP-100J2  
 NFP-200J2

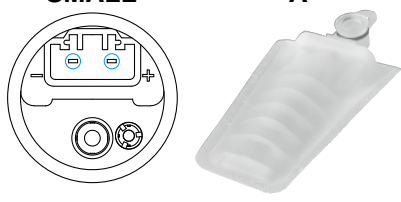
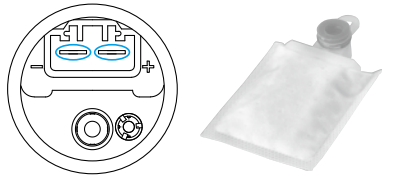
New-Era No.	Specification	Terminal & Filter	Application
<b>NFP-001JA</b> <b>NFP-001JB</b>  《UNIVERSAL》 GIP-502 CFP-102 DFP4301	Working voltage: <b>DC12V</b> Operating pressure: <b>0.3MPa(3bar)</b> Work flow: more than or equal to <b>100 ℓ/h</b> Working current: less than or equal to <b>6.0A</b>	<b>SMALL</b> <b>A</b> 	<b>TOYOTA</b>
<b>NFP-002JA</b> <b>NFP-002JB</b>  《UNIVERSAL》 GIP-501 CFP-101 DFP4300	Working voltage: <b>DC12V</b> Operating pressure: <b>0.3MPa(3bar)</b> Work flow: more than or equal to <b>100 ℓ/h</b> Working current: less than or equal to <b>6.0A</b>	<b>WIDE</b> <b>B</b> 	<b>HONDA</b> <b>ISUZU</b> <b>MAZDA</b> <b>MITSUBISHI</b> <b>NISSAN</b> <b>SUBARU</b> <b>SUZUKI</b> <b>HYUNDAI</b> <b>KIA</b>

### Application for NFP-001JA / NFP-001JB

TOYOTA/LEXUS	TOYOTA/LEXUS	TOYOTA/LEXUS
23220-02040	23221-0A030	23221-21030
23220-03020	23221-0A040	23221-21060
23220-03030	23221-0D010	23221-22030
23220-03040	23221-0D100	23221-22140
23220-0A020	23221-0F010	23221-28020
23220-0C010	23221-11050	23221-28030
23220-20020	23221-11070	23221-28280
23220-28220	23221-13010	23221-46010
23220-74020	23221-15030	23221-46070
23220-74021	23221-15040	23221-70350
23221-03010	23221-16490	23221-74090
23221-03030	23221-20030	23221-75030
23221-03040	23221-20040	23221-76030
23221-07010	23221-21010	
23221-0A020	23221-21020	

# FUEL PUMPS

Application for NFP-002JA / NFP-002JB

## HONDA/ACURA

17040-CV1-A31  
17040-S01-A30  
17040-S01-A31  
17040-S01-A40  
17040-S02-L00  
17040-S02-L01  
17040-S04-G30  
17040-S04-G31  
17040-S04-G40  
17040-S04-G41  
17040-S04-L00  
17040-S04-L01  
17040-S10-A00  
17040-S10-A01  
17040-S10-C20  
17040-S3M-A00  
17040-S5A-930  
17040-S5B-930  
17040-S7A-931  
17040-S84-A01  
17040-S84-A02  
17040-S84-A02  
17040-SAA-000  
17040-SDC-E00  
17040-SN7-E31  
17040-SN7-E31  
17040-SR1-A31  
17040-SR2-A31  
17040-SR2-A32  
17040-SR2-A33  
17040-SR2-A50  
17040-SR3-A31  
17040-SR3-A31  
17040-SS8-A00  
17040-SS8-A02  
17040-ST7-L00  
17040-ST7-L01  
17040-ST7-L30  
17040-ST7-L31  
17040-SV1-A30  
17040-SV1-A31  
17040-SV1-A31  
17040-SV1-A32  
17040-SV1-A32  
17040-SV1-L00  
17040-SV1-L01  
17040-SV1-L02  
17040-SW5-A30  
17040-SW5-A31  
17040-SW5-A31  
17040-SW5-A32  
17040-SW5-A32  
17040-SW5-A32  
17040-SX0-A32  
17040-SY8-A01  
17045-S5A-A00  
17045-S5A-A31  
17708-SOA-933

## ISUZU

5-86202-235-0  
5-86202-958-0  
5-86205-958-0  
5-86205-971-0  
8-94384-528-0  
8-94384-528-1  
8-94479-418-1  
8-94479-418-2  
8-97041-876-3  
8-97118-512-0  
8-97118-858-0  
8-97118-858-1  
8-97163-248-0  
8-97163-248-1

## MAZDA

1F21-13-350A  
AJ51-13-350  
AJ51-13-35Z  
B3C7-13-350  
B3E7-13-350  
B3E7-13-350A  
B3E7-13-35ZB  
B61P-13-350B  
B61P-13-ZE0  
B6BF-13-350  
B6BF-13-350MV  
B6BF-13-35Z  
B6BG-13-35Z  
B6DA-13-350  
B6DA-13-35Z  
BP4W-13-350A  
BP4W-13-35ZA  
BP4W-13-35ZF  
BP4W-13-35ZG  
BP8E-13-350  
BP8E-13-35Z  
CA01-13-350A  
CA01-13-35XC  
CA41-13-350  
CA41-13-35X  
CY01-13-350  
CY01-13-35XA  
GY01-13-350A  
GY01-13-35ZA  
JE45-13-35ZB  
JE47-13-35ZA  
JE48-13-35ZC  
KJ01-13-350  
KJ14-13-35Z  
KL19-13-350  
KL19-13-35ZB  
KL22-13-350  
KL47-13-350  
KL47-13-35ZB  
KLG4-13-35XB  
KLK1-13-35Z  
KLK1-13-35ZA  
L33L-13-35ZA  
L3F7-13-35ZC  
L518-13-350  
L518-13-35XB  
LF67-13-35XE  
LFB6-13-35XB  
LFB7-13-350  
LFB7-13-350  
LFG1-13-350  
ZL01-13-350  
ZL01-13-35Z  
ZL01-13-ZW1  
ZL02-13-ZE1  
ZL05-13-35ZA  
ZL05-13-35ZB  
ZZL0-13-350C  
ZZM4-13-350A  
ZZM5-13-350A  
ZZP0-13-350A  
ZZP1-13-350A  
ZZR0-13-350A  
ZZR1-13-350A  
ZZS1-13-350A  
ZZS3-13-350A

## MITSUBISHI

1760A233  
AW332718  
AW334174  
MB531263  
MB658436  
MB698623  
MB698857  
MB831262  
MB831263  
MB831264  
MB831333  
MB831560  
MB831561  
MB831562  
MB831691  
MB845502  
MB912304  
MB923663  
MB927016  
MB959729  
MB959730  
MB959847  
ME124999  
MN106213  
MN161720  
MN161721  
MN161935  
MR124765  
MR124881  
MR124999  
MR134284  
MR134804  
MR134806  
MR134868  
MR134901  
MR135420  
MR162453  
MR204500  
MR208665  
MR241080  
MR241083  
MR241351  
MR241394  
MR325884  
MR344715  
MR376042  
MR391856  
MR431087  
MR431088  
MR439710  
MR464198  
MR465687  
MR465688  
MR497143  
MR508115  
MR508282  
MR508283  
MR508284  
MR535803  
MR548361  
MR739710  
MR908180  
MR933638  
MR968070  
MR990817  
MR990818  
MR990883  
MR990884  
MR993339  
MR993340

## NISSAN/INFINITI

17040-3S500  
17040-3S505  
17040-3S515  
17040-4S400  
17040-5S105  
17040-8B000  
17041-5M015  
17042-0M005  
17042-0M013  
17042-0M021  
17042-0M023  
17042-0M024  
17042-0M077  
17042-0W005  
17042-0Z000  
17042-10S00  
17042-1E300  
17042-1E400  
17042-1E400B  
17042-1E400E  
17042-1W700  
17042-2B500  
17042-2Y900  
17042-31U00  
17042-31U05  
17042-31U08  
17042-4B000  
17042-4S400  
17042-5F600  
17042-5F600  
17042-5M010  
17042-5M800  
17042-5M802  
17042-5S700  
17042-5Y700  
17042-6J900  
17042-7B025  
17042-7J100  
17042-7J160  
17042-7J161  
17042-8B000  
17042-VE400

## SUBARU

42021AA020  
42021AA330  
42021AA350  
42021AC001  
42021AC010  
42021AC012  
42021AC013  
42021AC200  
42021AE02A  
42021FA090  
42021FA200  
42021FA250  
42021FC021  
42021FE020  
42022AE02A

## SUZUKI

15100-50G00  
15100-50G10  
15100-54813  
15100-54820  
15100-54830  
15100-54B30  
15100-54G10  
15100-57B20  
15100-58B00  
15100-58B01  
15100-58B10  
15100-60G00  
15100-60G20  
15100-60G21  
15100-60G20  
15100-61A02  
15100-61A10  
15100-61AA0  
15100-61AA1  
15100-65B11  
15100-65D02  
15100-65D12  
15100-65D22  
15100-65D30  
15100-65D31  
15100-65D32  
15100-65D70  
15100-65G00  
15100-66D32  
15100-77E00  
15100-80C10  
15110-50G00  
15110-50GT0  
15110-54G00

## HYUNDAI



31110-25700  
31110-33610  
31111-25000  
31111-25700  
31111-25750  
31111-26000  
31111-26300  
31111-28150  
31111-2D000  
31111-37150  
31111-37200  
31111-37300  
31111-38050

## KIA

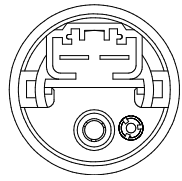

31111-07000  
31111-07600  
31111-2F500  
31111-38050  
31111-3H000  
31111-3K000  
OK01A-13-350B  
OK01B-13-350  
OK01B-13-350A  
OK01D-13-35ZA  
OK1D-13-35Z  
OK24C-13-35ZA  
OK24C-13-35ZA  
OK24T-13-35ZA  
OK29T-13-35Z  
OK29T-13-35ZA

# FUEL PUMPS

FUEL PUMPS

New-Era No.	Specification	Terminal & Filter	Application
<b>NFP-003JA</b> 	Working voltage: <b>DC12V</b> Operating pressure: <b>0.3MPa(3bar)</b> Work flow: more than or equal to <b>110 ℓ/h</b> Working current: less than or equal to <b>6.0A</b>	 	<b>TOYOTA</b> <b>SUBARU</b>  GIP-514 DFP4340 CFP-118

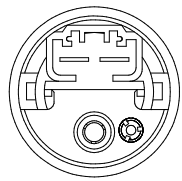
Ref No.	Application			
23220-0P030	<b>TOYOTA</b>			
23220-21170	4RUNNER	GRN210/UZN210	1GR-FE/2UZ-FE	02~09
23220-30011		TRN210	2TR-FE	04~09
23220-31180	HARRIER	ACU30	2AZ-FE	03~12
23220-50210		GSU30	2GR-FE	06~08
23220-51010		MCU30	1MZ-FE	03~06
23220-75170	HIGHLANDER	ACU20	2AZ-FE	00~07
23220-75171		MCU23	3MZ-FE	03~07
23221-0A050	HILUX SURF	GNR215	1GR-FE	05~09
23221-31050		TRN120/121	2TR-FE	02~09
23221-50100		RZN210	3RZ-FE	02~09
23221-62060		VZN210	5VZ-FE	02~05
23221-62070	KLUGER	ACU20/25	2AZ-FE	03~07
23221-75020		MCU20/25	1MZ-FE	03~07
77020-08031	LAND CRUISER	VDJ200	1CD-FTV	15~
77020-0E012	LAND CRUISER	GRJ120/121	1GR-FE	05~09
	PRADO	RZJ120	3RZ-FE	02~09
		TRJ120	2TR-FE	02~09
		TRJ150	2TR-FE	15~
42021-AG010		VZJ120/121/125	5VZ-FE	02~05
42021-AG100	PRIUS	NHW20	1NZ-FXE	
42022-AG05A	SIENNA	MCL20	3MZ-FE	03~06
	<b>LEXUS</b>			
	LX450/460/570	VDJ201	1VD-FTV	15~
	RX300	MCU35/MCU33	1MZ-FE/3MZ-FE	03~06
	RX350	GSU30/MCU38	2GR-FE/3MZ-FE	03~09
	<b>SUBARU</b>			
	FORESTER	SH5B/SH9A	205/155	07~11
	IMPRESA	G22, GP2	255	10~14
		GE2B/GE7B/GECB	154/204/253	10~14
	LEGACY	BL5F	204	05~11
		BL9F/BLEF	253/30D	03~11

New-Era No.	Specification	Terminal & Filter	Application
<b>NFP-003JB</b> 	Working voltage: <b>DC12V</b> Operating pressure: <b>0.3MPa(3bar)</b> Work flow: more than or equal to <b>110 ℓ/h</b> Working current: less than or equal to <b>6.0A</b>	 	<b>HONDA</b>  GIP-515 DFP4340A

Ref No.	Application			
17045-SNA-020	<b>HONDA</b>			
17045-SNA-A31	CIVIC	FD	K20A	06~11
		FA	R18A	07~08
		FD	R16A/R18A	09~11

# FUEL PUMPS

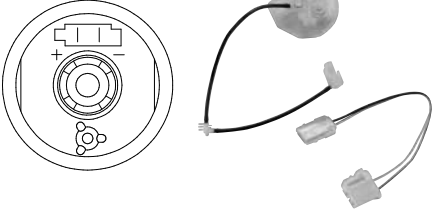
New-Era No.	Specification	Terminal & Filter	Application
<b>NFP-004JA</b> 	Working voltage: <b>DC12V</b> Operating pressure: <b>0.3MPa(3bar)</b> Work flow: more than or equal to <b>100 ℓ/h</b> Working current: less than or equal to <b>5.0A</b>		<b>TOYOTA</b> GIP-507 DFP4305
Ref No.	Application		
23220-75040 23220-75041	<b>TOYOTA</b> HIACE	TRH200 TRH201	1TR-FE      05~ 2TR-FE      05~

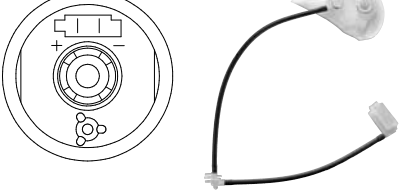
New-Era No.	Specification	Terminal & Filter	Application
<b>NFP-004JB</b> 	Working voltage: <b>DC12V</b> Operating pressure: <b>0.3MPa(3bar)</b> Work flow: more than or equal to <b>100 ℓ/h</b> Working current: less than or equal to <b>5.0A</b>		<b>TOYOTA</b> GIP-504
Ref No.	Application		
23220-0C080 23220-0C081 23220-0C120	<b>TOYOTA</b> INNOVA	TGN40	1TR-FE      04~16

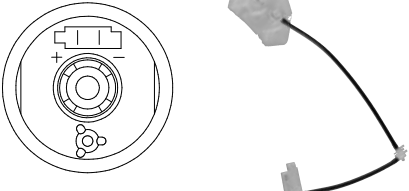
New-Era No.	Specification	Terminal & Filter	Application
<b>NFP-004JC</b> 	Working voltage: <b>DC12V</b> Operating pressure: <b>0.3MPa(3bar)</b> Work flow: more than or equal to <b>100 ℓ/h</b> Working current: less than or equal to <b>5.0A</b>		<b>TOYOTA</b> GIP-505 DFP4305A
Ref No.	Application		
23220-0C020 23220-0C050 23220-0C051 23220-0C130 23220-0P010 23220-0P160	<b>TOYOTA</b> FORTUNER HILUX  HILUX IMV HILUX SW4 HILUX VIGO INNOVA	GGN60/61 GGN15 GGN25 TGN15/26 TGN16 TGN51 TGN10/26 TGN41	1GR-FE/2TR-FE      05~ 1GR-FE                05~15 1GR-FE                15~ 1TR-FE/2TR-FE      05~ 2TR-FE                15~ 2TR-FE                05~15 1TR-FE/2TR-FE      05~15 2TR-FE                04~15

FUEL PUMPS

# FUEL PUMPS

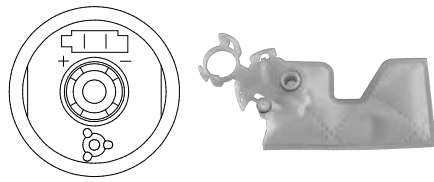
New-Era No.	Specification	Terminal & Filter	Application
<b>NFP-004JD</b> 	Working voltage: <b>DC12V</b> Operating pressure: <b>0.3MPa(3bar)</b> Work flow: more than or equal to <b>100 ℓ/h</b> Working current: less than or equal to <b>5.0A</b>		<b>TOYOTA</b> GIP-513 DFP4305C

Ref No.	Application			
23220-0H062 23220-0H072 23220-0H082 23220-0H151 77020-33200	<b>TOYOTA</b> CAMRY	ACV41 ACV40 ASV40	1AZ-FE 2AZ-FE 2AR-FE 2AZ-FE	06~15 06~12 09~11 06~09
	AURION	ACV40		

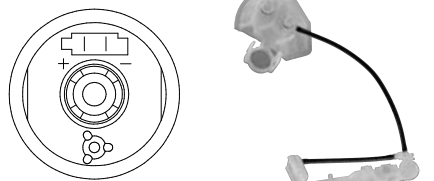
New-Era No.	Specification	Terminal & Filter	Application
<b>NFP-004JE</b> 	Working voltage: <b>DC12V</b> Operating pressure: <b>0.3MPa(3bar)</b> Work flow: more than or equal to <b>100 ℓ/h</b> Working current: less than or equal to <b>5.0A</b>		<b>TOYOTA</b> GIP-535 DFP4305B

Ref No.	Application			
23220-28090 23220-31120	<b>TOYOTA</b> RAV4	ACA30 ACA31 GSA33	1AZ-FE 2AZ-FE 2GR-FE	05~08 05~08 06~12
	VANGUARD	ACA33 GSA33	2AZ-FE 2GR-FE	07~13 07~12

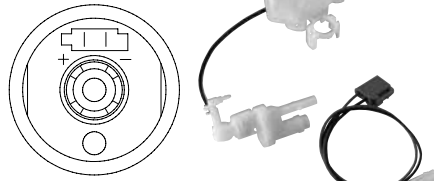
New-Era No.	Specification	Terminal & Filter	Application
<b>NFP-005JA</b> 	Working voltage: <b>DC12V</b> Operating pressure: <b>0.3MPa(3bar)</b> Work flow: more than or equal to <b>110 ℓ/h</b> Working current: less than or equal to <b>5.7A</b>		<b>TOYOTA</b>

Ref No.	Application			
23220-31230	<b>TOYOTA</b> ESTIMA	GSR50/55	2GR-FE	06~08

FUEL PUMPS

# FUEL PUMPS

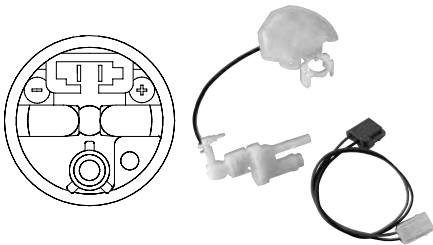
New-Era No.	Specification	Terminal & Filter	Application
<b>NFP-006JA</b> 	Working voltage: <b>DC12V</b> Operating pressure: <b>0.3MPa(3bar)</b> Work flow: more than or equal to <b>110 ℓ/h</b> Working current: less than or equal to <b>5.0A</b>		<b>TOYOTA</b>
Ref No.	Application		
23220-31350 77020-58010	<b>TOYOTA</b> ALPHARD VELLFIRE ESTIMA	GGH20/25 GGH20/25 GSR50/55	2GR-FE 2GR-FE 2GR-FE 08~11 08~11 08~11

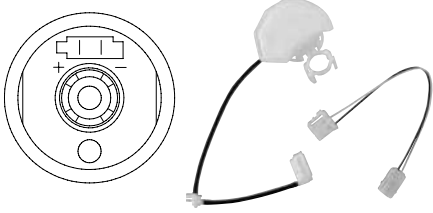
New-Era No.	Specification	Terminal & Filter	Application
<b>NFP-007JA</b> 	Working voltage: <b>DC12V</b> Operating pressure: <b>0.3MPa(3bar)</b> Work flow: more than or equal to <b>70 ℓ/h</b> Working current: less than or equal to <b>4.0A</b>		<b>TOYOTA</b> GIP-503 DFP4302
Ref No.	Application		
23220-0D170 23220-0M050 23220-0Q031 23220-0T121 23220-21131 23220-21132	<b>TOYOTA</b> BELTA RACTIS VITZ YARIS, ECHO VIOS, LIMO ALTIS	KSP92, SCP92 NCP100, SCP100 KSP90, NCP91 KSP90, NCP90 NCP91, NCP93 ZSP90	2SZ-FE 1NZ-FE 1NZ-FE, 2NZ-FE 1NZ-FE, 2NZ-FE 1NZ-FE 05~12 05~10 05~10 05~16 02~07

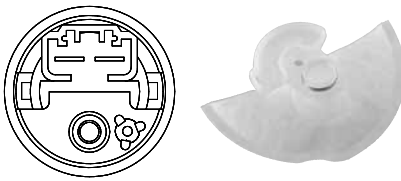
New-Era No.	Specification	Terminal & Filter	Application
<b>NFP-008JA</b> 	Working voltage: <b>DC12V</b> Operating pressure: <b>0.3MPa(3bar)</b> Work flow: more than or equal to <b>130 ℓ/h</b> Working current: less than or equal to <b>4.8A</b>		<b>TOYOT</b> <b>ACCURA</b> GIP-516 DFP4340B
Ref No.	Application		
17045-S3V-A50 17045-SDA-A00 17045-SDA-A30 17045-SDB-A00 17045-SDB-A30 17045-SDR-A00 17045-SEC-A00 17045-SEC-A01 17045-SEP-A01 17045-SWA-A00 17045-SXS-A00	<b>HONDA</b> ACCORD CR-V  <b>ACURA</b> MDX TSK	K24A J30A K24A J35A K24 J32 J35	03~05 03~07 07~10 03~04 04~08 04~08 07~08

FUEL PUMPS

# FUEL PUMPS

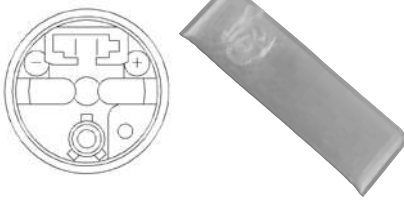
New-Era No.	Specification	Terminal & Filter	Application	
<b>NFP-009JA</b> 	Working voltage: <b>DC12V</b> Operating pressure: <b>0.4MPa(4bar)</b> Work flow: more than or equal to <b>80 ℓ /h</b> Working current: less than or equal to <b>5.0A</b>		<b>TOYOTA</b> GIP-541	
Ref No.	Application			
23221-47030 23221-47031	<b>TOYOTA</b> C-HR COROLLA AXIO PORTE PROBOX RACTIS SPADE SUCCEED VERSO VITZ YARIS	ZXY10 NRE160 NSP141 NCP160 NCP120 NSP141 NSP160 NSP120 KSP-130/NSP-130 KSP130/NCP-130	2ZR-FXE 1NR-FE 2NR-FKE 1NZ/1NR-FE 1NZ-FE 2NR-FKE 1NR-FE 1NR-FE 1KR/1NZ/1NR-FE 1KR/1NZ/2NZ-FE	16~ 12~ 15~ 14~ 10~16 15~ 14~ 10~16 10~ 11~14

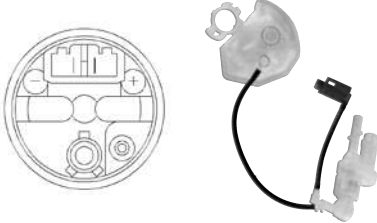
New-Era No.	Specification	Terminal & Filter	Application	
<b>NFP-010JA</b> 	Working voltage: <b>DC12V</b> Operating pressure: <b>0.4MPa(4bar)</b> Work flow: more than or equal to <b>80 ℓ /h</b> Working current: less than or equal to <b>5.5A</b>		<b>TOYOTA</b> GIP-536	
Ref No.	Application			
23220-36010 23220-36011	<b>TOYOTA</b> NX200 NX-300 HARRIER RAV4 RAV4	ZGZ10 AYZ15 ASU60/AVU65 ACA30/ACA31 ACA30/ACA31	3ZR-FAE 2AR-FXE 3ZR-FAE/2AR- FXE 1AZ-FE/2AZ-FE 1AZ-FE/2AZ-FE	14~ 14~ 14~ 13~ 08~16

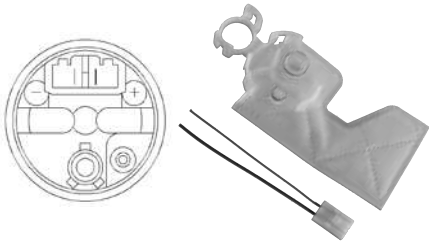

# FUEL PUMPS

New-Era No.	Specification	Terminal & Filter	Application	
<b>NFP-011JA</b> 	Working voltage: <b>DC12V</b> Operating pressure: <b>0.4MPa(4bar)</b> Work flow: more than or equal to <b>80 ℓ /h</b> Working current: less than or equal to <b>5.5A</b>		<b>TOYOTA</b> GIP-538	
Ref No.	Application			
23220-36061 23220-36130 23220-0V131 23220-0V180 77020-33312	<b>TOYOTA</b> CAMRY CAMRY HYBRID  <b>LEXUS</b> ES250 ES300H ES350	ASV50 ASV51 AVV50  ASV61 ASV61 ASV61	2AR-FE 6AR-FSE 2AR-FXE  6AR-FSE 6AR-FSE 6AR-FSE	11~ 15~ 12~  15~ 15~ 15~

FUEL PUMPS

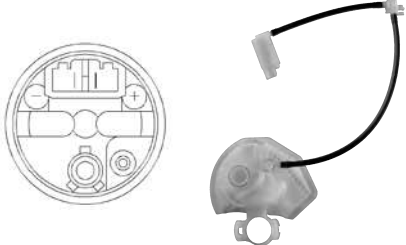
New-Era No.	Specification	Terminal & Filter	Application
<b>NFP-011JB</b> 	Working voltage: <b>DC12V</b> Operating pressure: <b>0.4MPa(4bar)</b> Work flow: more than or equal to <b>80 ℓ /h</b> Working current: less than or equal to <b>5.5A</b>		<b>TOYOT</b> GIP-539
Ref No.	Application		
23220-0T200 23220-0T211 23220-0T221 23220-0T241 23220-0C181 23220-21200 23220-21211 23220-37040	<b>TOYOTA</b> AQUA COROLLA COROLLA ALTIS  <b>INNOVA</b> <b>PRIUS</b>	1NZ-FXE 2ZR-FE 1ZR-FE 2ZR-FE 3ZR-FE 2TR-FE 2ZR-FXE 2ZR-FXE 1NZ-FXE 2ZR-FXE	11~17 14~ 13~ 13~ 13~15 15~ 09~ 11~ 11~17 15~





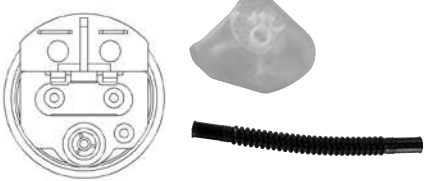

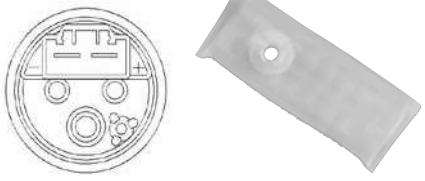
# FUEL PUMPS

New-Era No.	Specification	Terminal & Filter	Application
<b>NFP-012JA</b> 	Working voltage: <b>DC12V</b> Operating pressure: <b>0.3MPa(3bar)</b> Work flow: more than or equal to <b>100 ℓ /h</b> Working current: less than or equal to <b>5.5A</b>		<b>NISSAN</b>
Ref No.	Application		
17040-AX000 (PUMP ASSY No.)	<b>NISSAN</b> MICRA MARCH CUBE NOTE	CG10DE CG12DE CR14DE HR16D	CR10DE CR12DE 03~10 03~10 03~ 05~

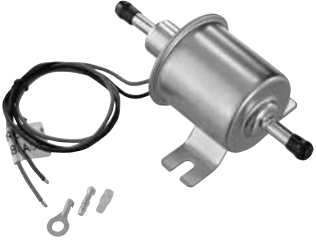
New-Era No.	Specification	Terminal & Filter	Application
<b>NFP-013JA</b> 	Working voltage: <b>DC12V</b> Operating pressure: <b>0.4MPa(4bar)</b> Work flow: more than or equal to <b>100 ℓ /h</b> Working current: less than or equal to <b>6.0A</b>		<b>TOYOTA</b> GIP-508
Ref No.	Application		
17042-VJ200 17042-VJ20A	<b>NISSAN</b> DATSUN TRUCK CIVILIAN	W41 D22	KA24DE TB45E 99~12 04~12

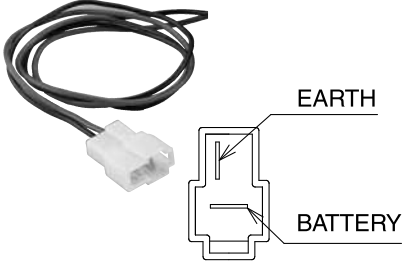
# FUEL PUMPS

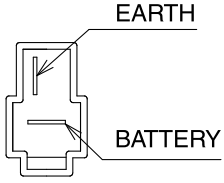
New-Era No.	Specification	Terminal	Application
<p><b>NFP-100J1</b></p> 	<p>Working voltage: <b>DC12V</b>            Operating pressure:  <b>0.03~0.04MPa(0.3~0.4bar)</b>            Work flow: more than or equal to <b>70 ℓ/h</b>            Working current: less than or equal to <b>2.0A</b></p>	 <p><b>without connector</b></p>	<p><b>MAZDA</b>            8118-13-350            1943-13-350            8788-13-350            HEP-02</p>
<p><b>NFP-100J2</b></p> 	<p>Working voltage: <b>DC12V</b>            Operating pressure:  <b>0.03~0.04MPa(0.3~0.4bar)</b>            Work flow: more than or equal to <b>70 ℓ/h</b>            Working current: less than or equal to <b>2.0A</b></p>	 <p><b>with connector</b></p>	<p><b>MAZDA</b>            8118-13-350            UNIVERSAL            HEP-02A            DFP4100</p>
<p><b>NFP-200J2</b></p> 	<p>Working voltage: <b>DC12V</b>            Operating pressure:  <b>0.01~0.02MPa(0.1~0.2bar)</b>            Work flow: more than or equal to <b>42 ℓ/h</b>            Working current: less than or equal to <b>1.7A</b></p>		<p><b>SUZUKI</b>            15100-85500            15100-85501            UC-V4            DFP4210</p>